

Physical Education, Health Science and Sports

Classes Nine-Ten

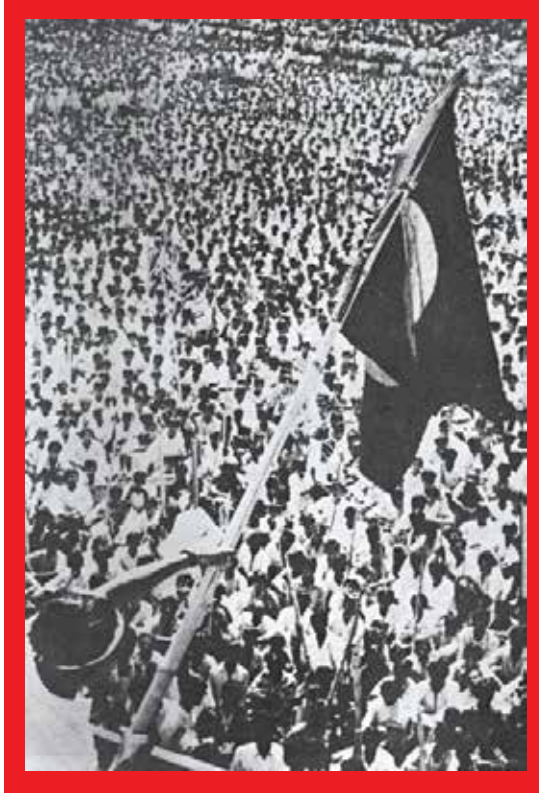

NATIONAL CURRICULUM AND TEXTBOOK BOARD, BANGLADESH



ছাত্র জনতার বিশাল সমাবেশে বাংলাদেশের মানচিত্র খচিত
বাংলাদেশের পতাকা উত্তোলন (২ মার্চ, ১৯৭১)

১৯৭০ সালে সাধারণ নির্বাচনে জাতীয় পরিষদের পূর্ব পাকিস্তানের ১৬৯টি আসনের ১৬৭টিতেই আওয়ামী লীগ জয় লাভ করে এবং আওয়ামী লীগ নেতা বঙ্গবন্ধু শেখ মুজিবুর রহমান পূর্ব পাকিস্তানের (বর্তমান বাংলাদেশ) জনগণের একক নেতা হিসেবে আবির্ভূত হন। তিনি হন পাকিস্তানের জাতীয় পরিষদের সংখ্যাগরিষ্ঠ দলের নেতা কিন্তু পাকিস্তানের সামরিক ও বেসামরিক নেতৃত্ব সংখ্যাগরিষ্ঠ আওয়ামী লীগ ও তার নেতা বঙ্গবন্ধু শেখ মুজিবুর রহমানের হাতে ক্ষমতা হস্তান্তর করতে অস্বীকার করে। ১৯৭১ সালের ৭ই মার্চ বঙ্গবন্ধু শেখ মুজিবুর রহমান রেসকোর্স ময়দানে (বর্তমান সোহরাওয়ার্দী উদ্যান) বিশাল জনসমাবেশে ভাষণ দেন। শুরু হয় অসহযোগ আন্দোলন। ইতোমধ্যে সমস্যা নিরসনে শেখ মুজিবুর রহমান ও ইয়াহিয়া খানের মধ্যে আলোচনা শুরু হয়। একপর্যায়ে আলোচনা ব্যর্থ হয়ে যায়। ১৯৭১ সালে ২৫শে মার্চ মধ্যরাত থেকে পাকিস্তানি সেনাবাহিনী নিরস্ত্র বাঙালিদের উপর ঝাঁপিয়ে পড়ে। শুরু করে বাঙালি নিধন। একই রাতে পাকিস্তানি সৈন্যরা বঙ্গবন্ধু শেখ মুজিবুর রহমানকে গ্রেপ্তার করে পাকিস্তানে নিয়ে যান। গ্রেপ্তারের পূর্বক্ষণে বঙ্গবন্ধু শেখ মুজিবুর রহমান বাংলাদেশকে স্বাধীন, সার্বভৌম রাষ্ট্র বলে ঘোষণা করেন এবং সর্বস্তরের জনগণকে পাকিস্তানি সেনাবাহিনীর বিরুদ্ধে সশস্ত্র প্রতিরোধ গড়ে তোলার নির্দেশ জারি করেন। ২৬শে মার্চ মাইকিং করে এবং কালুরঘাট ট্রান্সমিশন কেন্দ্র থেকে বঙ্গবন্ধুর স্বাধীনতার ঘোষণা দেশব্যাপী প্রচার করা হয়।

**Prescribed by the National Curriculum and Textbook Board
as a textbook for classes nine and ten from the academic year 2013**

Physical Education, Health Science and Sports

Classes Nine-Ten

Written by

Abu Muhammad

Md. Abdul Haque

Edited by

Professor A B M Faroque

Translated by

Dr. Md. Arafe Zawad

Md. Abdul Mannan

NATIONAL CURRICULUM AND TEXTBOOK BOARD, BANGLADESH

Published by
National Curriculum and Textbook Board
69-70, Motijheel Commercial Area, Dhaka

[All rights reserved by the publisher]

First Edition : November, 2012
Revised Edition : July, 2015
Reprint : , 2022

Design

National Curriculum and Textbook Board, Bangladesh

For free distribution by the Government of the People's Republic of Bangladesh
Printed by :

PREFACE

The aim of secondary education is to make the learners fit for entry into higher education by flourishing their latent talents and prospects with a view to building the nation with the spirit of the Language Movement and the Liberation War. To make the learners skilled and competent citizens of the country based on the economic, social, cultural and environmental settings is also an important issue of secondary education.

The textbooks of secondary level have been written and compiled according to the revised curriculum 2012 in accordance with the aims and objectives of National Education Policy-2010. Contents and presentations of the textbooks have been selected according to the moral and humanistic values of Bengali tradition and culture and the spirit of Liberation War 1971 ensuring equal dignity for all irrespective of caste and creed of different religions and sex.

Honorable Prime Minister, Government of the People's Republic of Bangladesh, Sheikh Hasina expressed her firm determination to make the country free from illiteracy and instructed the concerned authority to give free textbooks to every student of the country. National Curriculum and Textbook Board started to distribute textbooks free of cost since 2010 according to her instruction. In its continuation, this textbook has been reviewed and updated with a view to create a developed and resourceful Bangladesh keeping vision 2041 ahead.

The subject **Physical Education, Health Science and Sports** is developed on the basis of the philosophy of sound health and fresh mind. Basically it is a practical oriented subject. So it has been tried to co-orient between both the theoretical part and the practical part for learning practically and also for life-oriented and realistic education. Student will achieve clear idea about their health care, knowledge of nutrition, personal security and reproductive health. Learners will be conscious about the dreadfulness of drug addiction, AIDS and therefore they will be free from all these. Besides, they will be able to develop themselves to be a healthy and active citizen by learning the rules and regulations of different kinds of physical exercises and games.

I thank sincerely all who were involved in the process of revision, writing, editing, art and design of the textbook for their intellectual labour.

Professor Md. Farhadul Islam

Chairman

National Curriculum and Textbook Board, Bangladesh.

Contents

Chapter	Subject	Pages
One	Physical Education for Healthy Life	01-12
Two	Physical Fitness	13-24
Three	Mental Health and Fatigue	25-33
Four	Health Science and Health Service	34-47
Five	Nutrition for Health	48-57
Six	Drug Addiction and AIDS	58-74
Seven	Puberty & Reproductive Health	75-92
Eight	Team Game	93-140
Nine	Athletics and Swimming	141-167
Ten	The Accidents during Games	168-184

Chapter One

Physical Education for Healthy Life

In the past it was traditionally thought that physical education means physical activities. But it was a wrong conception. Physical activities do not necessarily mean physical education rather they may be called physical exercise. Issues of physical education not only deal with physical activities but they help in attaining mental development and social virtues as well. When your body is not fit, you do not feel mentally well and cannot concentrate on any work. Thus relationship between body and mind is intertwined and they cannot be studied separately. The old saying, "a sound mind in a sound body" has been regarded as a universal truth in all ages. At present acquisition of physical development, mental growth and social skills is physical education. We can get sound life by regular practising the programmes of physical education. A student of physical education will develop a sound mind in a healthy body so that they become a good citizen of the society.

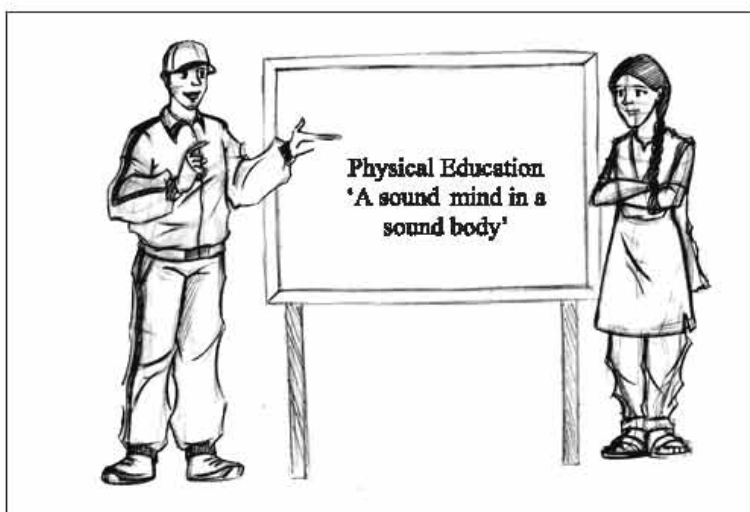

At the end of this chapter we will be able to—

- explain aims and objectives of physical education;
- explain the necessity of physical education for healthy life;
- explain concepts of physical education programmes;
- discuss current status of physical education in Bangladesh;

- observe different physical education programmes such as interclass, interschools, intermadrasah sports competition, programme of national day properly;
- be habituated to leading a discipline life; participate in various physical education programmes.

Lesson- 1: Physical Education

To say something about physical education or to define it first we need to know what education is. Physical education is an integral part of the total education process. Without physical education, education remains incomplete. A definition of education will make it easy for us to understand what physical education is. Different scholars have defined education in different ways, which are related to different situations. Education is not only intellectual development, it also includes physical, social, and emotional and all round development of other areas. Education is not limited to a specific point of time in an individual life but it takes place throughout the life. Education is not confined to the boundary of a school but it may be acquired from family, society, playground and so on.

A few relevant definitions of education-

- According to Plato- "Education helps in the body and soul of the pupil all the beauty and all the perfection he is capable of".
- Another scholar defines education as the creation of a sound mind in a sound body.
- It is also defined that education is the harmonious development of body, mind and soul.
- According to Charles A Bucher, "physical education is an integral part of the total education process and its aim is the development of physically, mentally, emotionally and socially fit citizens, through physical activities which have been selected with a view to realizing their outcomes".

From above definitions it is clear that education and physical education are complementary to each other.

D.K. Matthews says, "Physical education is the education which is acquired through physical activities".

Hop smith and Clifton says, “Physical education refers to scientific and systematic movement of limbs”.

According to **J.B. Nash**, physical education is the part of the whole field of education that deals with big muscle activities and their related responses that bring changes in an individual’s body and personality. From the above definitions it is found that the essence of physical education is all-round development of an individual’s personality. As a result of physical education one becomes physically fit, mentally sound, emotionally balanced, socially adjusted, morally true and spiritually up-lifted. All this outcomes are achieved by means of recreational activities of games and sports.

Activity-1: Write the definitions of physical education on poster paper and display it on the wall.

Lesson-2: Aims and Objectives of physical Education

Generally we do not differentiate between an aim and an objective in most cases. We often use them interchangeably. But these two terms are not synonymous. There are differences between them. Aim is the final goal whereas an objective is a short and specific step towards the goal. For example, in case of your climbing the stairs to reach the roof, the roof is the aim and every step of the stairs is an objective. An aim exists in human imagination which can not be depicted in reality. But an objective is real. Man can achieve the objective and even it is possible to measure. Physical educationists have mentioned several interim measures to attain the aims. These measures are known as the objectives of physical education. According to Williams, the aim of physical education is all-round development of personality through development of physical, social and other areas of an individual. Book Walters states that the aim of physical education is the optimum development of the physically, socially and mentally integrated and adjusted individual. This aim can be achieved through participation in selected sports, rhythmic, and

gymnastic activities conducted according to social and hygienic standards. Though experts have agreed upon some objectives, there are different opinions about some other objectives as well. From the opinions of the majority of experts we can identify common objectives of physical education. Considering the opinions of various thinkers, the objectives of physical education can be divided into four groups. They are-

- 1) Physical fitness.
- 2) Mental development.
- 3) Character development.
- 4) Social adjustment.

1. Physical fitness

- a) To play well, maintaining the rules and regulations of games and sports
- b) To achieve specific objectives through hard work
- c) To improve human capacity through neuro-muscular coordination
- d) To ensure balanced development of body and mind
- e) To attain physical strength maintaining good health
- f) To develop tolerance and self-confidence

2. Mental development

- a) To develop quick thinking ability
- b) To acquire knowledge about ethics & morality
- c) To be motivated for service and self-sacrifice
- d) To foster friendly and competitive attitudes among different teams

3. Character developments

- a) To develop a sense of obedience and morality
- b) To develop respect for law through games and sports
- c) To develop sportsman like and friendly attitudes
- d) To show respect for opponents
- e) To help control emotions and become self-disciplined

4. Social adjustment

- a) To acquire leadership qualities
- b) To know constructive ways of passing leisure time
- c) To develop ability to participate in various cultural programmes
- d) To maintain friendly relationship with others and to participate in welfare activities

From the opinions of the physical educationists as mentioned above, it can be said that the objectives of physical education are very similar to that of general education. It also focuses on optimum development of personality of individuals and also on helping them master the art of games and sports through systematic guidance and participation in sports.

Activity-1: Write the aims and objectives of physical education on a poster paper and display it on the wall.

Activity-2: In groups explain what can be acquired through the objective-social adjustment.

Activity-3: Write down the objectives of physical fitness on the board.

Lesson-3: Needs of Physical Education

Physical education maintains co-ordinated development of body and mind. Any education is not complete without physical education. Physical education plays a vital role in inculcating those qualities into people, which help individuals to grow as healthy, emotionally-balanced and responsible citizens. Men loves recognition by society. It is through recognition that an individual's personality is developed. Therefore, physical education has a significant role in developing leadership and personality. Our body is a combination of some organs. Again, each organ consists of different types of muscles, bone, artery, vein etc. In order to keep the body fit a number of systems are functioning inside the body. Physical fitness is a must to keep these systems functional. As a result of lack of balanced nutrition, lack of necessary physical movements, required rest and sleep, the body does not develop properly and fails to

keep fit. In fact, modern education puts equal emphasis on physical and mental development. The necessity of physical education at school is described sequentially–

A school is a social institution, so a school is committed to the society and the country for social conservation, social reforms, and positive social changes. School is responsible for the proper development of human resources to develop the children of today as the good citizens of tomorrow. In this respect the school plays dual roles. First, the prime duty of a school is to help its young students to develop their personality, which includes physical, mental and spiritual aspects of students. Secondly, schools help the students transform biological entities into social ones. It includes development of character, social values and social adjustment.

Out of these two tasks, the first one is direct responsibility whereas the other one is the indirect responsibility of a school. Physical education is necessary for all-round development of a student. According to Maslo, these needs of a student are divided into three stages.

1. Biological needs
2. Psychological needs
3. Social needs.

1. Biological needs: Physical education has direct contribution in the fulfillment of biological needs of a student. The role of physical education is as follows–

- a) Physical education fulfils biological needs of the body of students by quick movements.
- b) It makes beautiful and strong physical structure of a student.
- c) It develops physical ability and capacity of students.
- d) It develops immunity to diseases of students.
- e) Students acquire expertise in sports through learning skills of various games.
- f) Physical education develops a sound body for a sound mind.

2. Psychological needs:

- a) Physical education builds mental and intellectual foundation of children.
- b) It removes monotony and boredom of everyday life of students.
- c) It develops character of students.

- d) It develops self-awareness, self-dependence, self-realization and self-respect among the students.
- e) It helps student to adjust with environment.
- f) It develops a sense of creativity among the students.
- g) It keeps students away from harmful addictions.
- h) It helps students choose the means of recreation and enjoy pastimes.

3. Social needs:

- a) Physical education helps students to develop co-operative attitude through competition.
- b) It helps to develop mental qualities which reflect social relationships through games & sports.
- c) It develops leadership qualities.
- d) It makes students familiar with social norms and culture.
- e) It prompts national and international fraternity.
- f) It creates liberal attitudes and a sense of social responsibility among the students.

Activity-1: Discuss biological needs in small groups.

Activity-2: The class will be divided into three groups and each group will discuss and explain at least two of the psychological needs.

Activity-3: Show the social needs on the board.

Lesson-4: Programmes of Physical Education

Programmes of physical education in an educational institute include games and sports, physical exercise and all other health as well as recreational related activities. A physical education teacher helps students to perform all these activities in physical education programmes.

Physical education programmes are divided into three categories-

- 1) Compulsory Sports programme
- 2) Intramural Sports
- 3) Extramural sports

1. Compulsory Sports Programme: In an educational institution sports programme of physical education includes government instructions about physical education, physical education class, competition, assembly and local instructions etc. A physical education teacher has to observe all these programmes. By government instructions mean the orders and circulars issued by ministry of education relating to physical education programmes such as compulsory daily assembly, three classes a week, participation in inter school sports competition and games and sports on national days and so on. By local instructions we mean the rules and regulation of an institution such as maintaining cleanliness of campus, participation in annual sports competition, participation in cultural programmes, participation in physical development test and running tiffin programme etc.

2. Intramural Sports: Intramural is a Latin word. Intra means inside and mural means wall. So intramural sports mean all the games and sports taking place within the boundary of a school. For example, annual sports competitions, class ix vs x cricket match, or class vi A section vs vi B section competition of any type etc. If there are different houses in the school, competitions between them are also called intramural activities. Besides, competitions between departments or first year vs second year are also included under intramural sports. In short, all the sports or competitions that take place within the institutions are called intramural sports.

3. Extramural Sports: Extra means outside and mural means wall. So all the games and sports competitions taking place outside the boundary of a school are called extramural sports. The games and sports or any type of competition of one school or college with another school or college are commonly called extramural competitions. For examples, inter school, inter college, inter university, inter club etc. By participating in an extramural competition the strength of one's own team can be tested. Players of different standards participate in such types of competitions. As a result of coming in close contact with good players, one can learn good behavior and better technique from them. Through these competitions students can develop team spirit, mutual understanding, competitive attitude and good relationship.

Activity-1: Discuss in groups the programmes of physical education.

Activity-2: Write on the board what you understand by compulsory sports programmes.

Activity-3: Show the differences between intramural and extramural sports programmes on poster paper.

Lesson-5 : Physical Education in Bangladesh

Physical education is related integrally to general education to make education complete, effective and meaningful. Physical education works as one of the catalysts. Before the renaissance in Europe, education was chained with regulations. At that time, there was no such thing as physical education in educational institutions. Physical education was considered to be a context in military power. A major change took place during the age of renaissance to build up a citizen for the improvement of the country. Physical education programmes were introduced in the educational institutions to build a nation both physically and mentally sound. After many experiments, the modern physical education was introduced in Europe. After proving its usefulness in educational institutions, it spread out in the whole world.

The European physical education system was introduced in the then British India on a limited scale. After the partition of the country in 1947, physical education programmes were introduced in the educational institutions of the then Pakistan. At that time the appointment of teachers, arrangement of playgrounds, sports instruments, inter-school, inter-college and inter-university tournaments were introduced for physical education by the government. As a continuation of this programme, physical education was introduced in Bangladesh, which achieved its freedom by the liberation war in 1971.

In Bangladesh activities based on the management and programmes of physical education have been continuing. The Ministry of Youth and Sports administers the management of physical education. Under its jurisdiction, the Directorate of Sports inspects the administrative and training programmes in the six government physical training institutes of the country. After getting training from these institutes, teachers are appointed in different educational institutions as physical instructors. These physical instructors are conducting the physical education programmes or arranging the sports tournaments. Besides that, the District sports officer working under the Sports Department provides help for

conducting the sports programmes taken by the government. On the other hand, the Directorate of Education under the Ministry of Education arranges the National School and Madrasah Sports Tournament twice every year under the charge of one Deputy Director and one Assistant Director. Also under their arrangement, the refresher's course for the school level physical instructors is conducted.

Considering the importance of physical education, the government has made the subject 'Physical Education and Health' compulsory from classes 6-8 and 'Physical Education, Health Science and Sport's for classes 9-10. For this purpose, necessary books have been written by National Curriculum and Textbook Board. Teachers of primary level give the idea and knowledge of physical education to the children by teachers guide of physical education.

The physical education programmes have been made more dynamic by the age-based tournaments and trainings at school level. It is expected that, by expanding and developing the physical education programmes, better results of physical education will be achieved in national life.

Activity-1: Discuss the status of physical education in Bangladesh.

Activity-2: Write down the different programmes of physical education in Bangladesh.

Exercise

Multiple choice questions

- Who said 'The knowledge acquired through physical activity is called physical education'?
 - J. B. Nash
 - D. K. Matthews
 - C. A. Bucher
 - Hopsmith and Clifton.
- What is the objective of physical education?
 - Development of leadership
 - Developing personality
 - Building up character
 - Social development
- Under whose guidance the students gain slowly their humanitarian qualities?
 - Family
 - Society

- c. Teachers
- d. Friends
4. The objective of gaining the qualities of character in physical education is -
- to be respectful to the laws.
 - to develop friendly mentality.
 - to increase loyalty and ethics.
- Which one in the following is correct?
- i & ii
 - ii & iii
 - i & iii
 - i, ii & iii

Read the stem and answer questions 5 & 6.

Mehnaz is a good student of class eight. She does not participate in any games at school. And she does not have friends. Her mother asks her to read all day long. Mother frequently tells her that good results cannot be done by wasting time in playing or mixing with relatives and friends. So, by reading all day long, one can become successful. If any guest comes to their house, she keeps herself alone in a room. Thus, after several years, she becomes a bit worried about her life.

5. In the case of Mehnaz, which development has been obstructed?
- Physical
 - Mental
 - Character
 - Social
6. What to do to solve the mentioned condition of Mehnaz?
- Practicing physical exercise
 - Socialisation
 - Training

Which one in the following is correct?

- i & ii
- ii & iii
- i & iii
- i, ii & iii

Read the stem and answer question no 7

Daily assembly

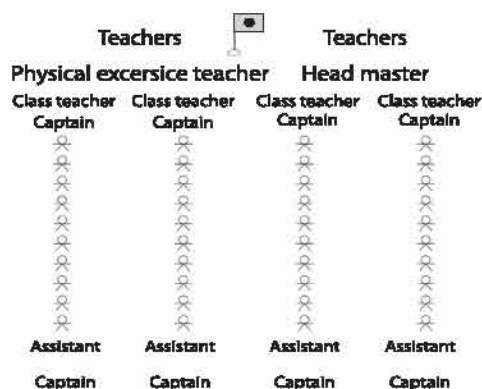

7. In which programme is the picture included?
- a. inner-sports b. compulsory
 - c. inter-sports d. local-sports

Creative Question

1. Rayhan's grandfather became very happy seeing the playground, physical instructor, their physical exercises and sports programmes at Rayhan's school. Coming back from school, Rayhan described to his grandfather some more features of physical education, such as sports instruments, indoor and outdoor games, inter-school sports tournaments, etc. Through a few visits to Rayhan's school, Rayhan's grandfather observed that most of the students of Rayhan's school are sound in health.
 - a. What is the first duty of an educational institution?
 - b. Explain - Education is a lifelong process.
 - c. Which programme is running at Rayhan's school to build up both body and mind?
 - d. Explain - Through the above mentioned programme student's 'sound body and sound mind' can be built up.
2. Two periods are reserved every day at Nalanda High School for physical exercise and sports. The school authority provides nutritious foods to the students while they are at school. They are provided with a daily routine to follow. Besides, the school authority organises various events including debate competitions, cultural and national day's functions. For this, they can easily mix with everyone at any situation.
 - a. What is inter-sports programme?
 - b. Explain - What is meant by compulsory programme?
 - c. What is the first work of Nalanda High School? Explain in the light of the stem.
 - d. Through the development of the values of having good character and social qualities, the school students, in fact, have become social beings. Evaluate.

Chapter Two

Physical Fitness

The main objective of physical education is to gain physical fitness. So it is important for students to have a clear idea about the features of physical fitness their relation with games and sports and ways of evaluating physical fitness. Students can develop physical fitness through physical exercise though there are differences in types of physical exercise for boys and girls. They should know the role of specific games and sports in developing strength, endurance, speed, power, agility, and flexibility. Students will be able to lead healthy and disciplined life by gaining physical fitness.

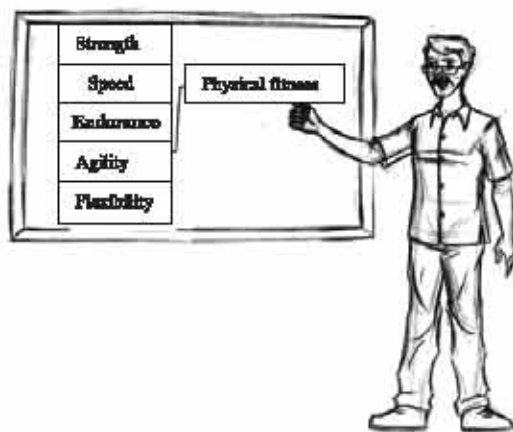

At the end of this chapter we will be able to–

- explain the importance of physical fitness;
- explain the ways of attaining physical fitness;
- explain the positive aspects of physical exercise for attaining physical fitness;
- describe and practise which physical exercise is suitable for boys and girls to have physical fitness;
- analyze the effects of strength, speed, endurance, power, agility, flexibility in attaining physical fitness;
- do the appropriate exercise to develop strength, speed, endurance, power, agility, flexibility for physical fitness.

Lesson-1: Importance of Physical Fitness

Generally physical fitness means the ability to do work. In broader sense physical fitness refers to the ability of maintaining health and normal life related to the biological existence. Physical fitness includes one's physical, mental and social fitness. Therefore, it is regarded that physical fitness and wellness are a holistic approach. A man with physical fitness can also maintain mental health, emotional balance and social relationship beside physical health to explain physical fitness as a holistic approach. A sports journal named AAHPER (American Association of Health, Physical Education and Recreation) has included the followings as physical fitness.

- a) Physical health according to genetic inheritance
- b) Strength, speed, endurance, coordination and techniques required to perform day to day activities and to face emergency
- c) Proper attention and values for performing day to day activities
- d) Necessary emotional balance to manage stress of complex lifestyle
- e) Capacity to adjust with team and required social awareness
- f) Required knowledge and analytical power to solve the problems faced in life
- g) High morality and strong personality to perform duties and responsibilities as a good citizen of a democratic country.

Therefore the concept of fitness includes total fitness of an individual. In fact, fitness is based on the concept of totality of a human. Among all the components of total fitness the most practical, the most essential and the most primary component is physical fitness. This aspect of fitness is vital for maintaining biological existence. Physical fitness is the ability to perform physical activity. So the degree of physical fitness level varies depending on nature of physical activity. For this reason, physical fitness of a common person for walking, moving, sitting and doing other day-to-day activities and the physical fitness of a player are not the same. A clear defined physical fitness is "The ability to carry out everyday task with vigor and alertness, without undue fatigue and with ample energy to enjoy leisure time pursuits and to meet unforeseen emergencies. Many people think that in this technology based modern life where physical activity has been decreased remarkably the

above definition of physical fitness is not fully applicable in our context. The capacity of physiological organs and the systems and ability to adjust to environment are some important dimensions of physical fitness.

Importance of Physical Fitness

A student who acquires physical fitness will be able to live a healthy life overcoming all the odds and dangers of life. For example:

- 1) To perform any physical activity smoothly.
- 2) To be able to face any emergency situation.
- 3) To develop immunity to fight diseases
- 4) To be attentive in study with fresh mind through attaining physical fitness.
- 5) To develop skills required for any types of game.

Activity-1: What is meant by physical fitness. Write on a poster paper and show to the class.

Activity-2: Discuss the importance of physical fitness in groups.

Lesson-2: Variation of Games for Gaining Specific Physical Fitness

There are different types of physical exercise for different games. A single type of physical exercise is not applicable for all games. For example, the strength of hands is more required in some games where as the strength of legs is more important in some other games. Game specific physical exercises are essential for doing better in that game. For example–

Football: In football most important components of physical fitness are strength, endurance and agility. Therefore, football players should take exercise more to develop their strength, endurance and agility.

Swimming: Swimmers need to do more exercise to improve their strength of hands and legs and higher endurance.

Basketball: The basketball players should give emphasis to the development of endurance, agility and strength of legs.

Volley ball: Good strength of hands helps volleyball players smash the ball. So volley ball players should take physical exercise to improve the strength of hand.

Handball: Handball players require explosive power of hands and legs agility and endurance to do well in the game. So physical exercise is suitable for improving explosive power of hands and legs. Endurance and agility are important for them.

Kabaddi: The kabaddi is known as a game of strength, but only strength is not enough to do well as a kabaddi player. In kabaddi, strength and agility are more important than other components. Kabaddi players should take special care to improve strength and agility.

The following chart shows types of physical fitness for specific games.

Requirement of physical ability is shown in the table below:

Game	Endurance	Agility	Energy			Age upto
			leg	abdomen	hand and arm	
Football	H	H	H	M	H	35 years
Cricket	M	M	H	M	H	40 years
Handball	M	H	H	M	H	all age
Volley ball	L	M	M	M	H	30 years
Hockey	H	H	H	M	H	30 years
Basketball	H	H	H	L	L	30 years
Swimming	H	M	H	M	H	30 years
Sprint	M	H	H	M	H	40 years
Long-distance running	H	L	H	M	M	40 years
Kabaddi	M	H	H	M	H	35 years
Badminton	H	H	H	M	M	45 years

H-Highly necessary, M- Moderately necessary, L-Less necessary

Activity-1 : What types of physical fitness are required for a football player?

Activity-2 : Write down on board the differences of physical fitness between a sprinter and a long distance runner.

Lesson-3: Importance of Physical Exercise According to Age and Sex

According to Age: Physical education is applicable for people of all ages. But programmes of physical education differ likings & dislikings for different age-groups. Not only physical exercise but also food, likings and dislikings and physical abilities are different for different age-groups. For example, physical ability of children is not equal to that of adults. So to develop the abilities exercise through games should be introduced accordingly. Frog jump, touch and back, crow jump or recreational games are some physical activities that can improve physical ability of children. Selection of exercise and games for adolescent should be done systematically. Standing in a line, exercise of hands and legs, running with a ball, touch and play, etc. and games and physical exercise can be used to develop physical abilities of children. Remember, children and adolescents should not participate in weight lifting exercise. It causes harm to the body. Youths should take part in exercise systematically. So they can learn skills of different games which will build foundation in sports. We should keep in mind that exercise may cause fatigue among students. Selection of physical exercise for specific part of the body is essential. Physical ability may be acquired in this way. For elderly people light physical exercise is required for maintaining physical ability.

According to Sex: Though physical education is equally important for all, but it depends on how much we can implement it. And though it is different for man and women, it cannot be so for childhood. Physical structures of boys and in their childhood are more or less the same. Priority should be given to recreational games, imitating activities, jumping and running etc. at the time of designing physical education programmes for children. To ensure mental development of children, physical education programmes for children should be implemented through games and sports. There is little difference between boys and girls during 7-12 years of age. This time girls do not participate in any heavy games. Boys show more interest in team games though both boys and girls participate in individual games. For example, badminton, table tennis, running etc. are a few individual games. From this stage, physical education programmes should be separated to develop their physical capacities. After the

reach to puberty, physical changes take place among boys and girls. For this reason their activities are also different. Boys like athletics, swimming etc. beside team games. Most of the boys do not hesitate to take a risk at this stage. In the behavior of girls hesitation and shyness appear due to their physical changes. This is why physical education programmes of girls differ from that of boys in games and sports competitions such as swimming, athletics, badminton, table tennis etc. For boys and girls, there being big differences in physical strength and tolerance, physical education activities are different. Therefore, as children grow up, difference in their physical activities become distinct. Boys and girls participate in these activities separately.

Activity-1: Make a list of physical education activities suitable for children and adolescents according to their age.

Activity-2: Discuss why physical activities of girls are separate from those of boys during puberty.

Lesson-4: Effect of Exercise on Physical Fitness

Exercise is essential for physical fitness. Without physical exercise none can develop physical fitness. People of all ages should take regular exercise systematically and follow the methods of sports training. Many changes take place inside the body due to exercise, which develops physical fitness. The changes that take place due to exercise are given below-

Heart Muscle

1. Develop strong cardiac muscle: Blood circulation increases due to physical exercise or games. As a result, efficiency of heart develops. Heart muscle becomes strong. Heart volume increases and becomes disease-free as efficiency of heart increases. The heart of this type is called an athletic heart.

2. Pumping capacity of heart increases: Heart of common people pumps 130 millilitre of blood. Blood circulation increases due to exercise. So pumping capacity of heart increases. And heart becomes strong, efficient and develops immunity.

3. Pulse rate: Pulse rate increases if common people take exercise or do work. It usually takes time to become normal. Tiredness do not disappear easily. On the other hand, pulse rate of a good player increases and becomes normal faster after he/she takes part in exercise or participate in games and sports. Therefore players recover faster from fatigue than common people.

4. Blood circulation: One takes part in exercise or participates in games and sports to increase blood circulation. So, the efficiency of heart muscle increases more and becomes stronger than that of common people.

5. Blood cell: There are three types of blood cells.

a) Red blood cells (Erythrocytes)

b) White blood cells (Leukocytes)

c) Platelets (Thrombocytes)

a) Red blood cells: The amount of red blood cells in blood is high. The amount of red blood cells in male is about 50,00000 per cubic millilitre of blood and about 45,00000 per cubic millilitre in female. It produces in bone marrow and damages in spleen after 120 days. The number of red blood cells increases and live long due to effect of exercise. Red blood cells with the help of haemoglobin supply oxygen to different parts of the body and control body temperatures.

b) White blood cells: The amount of white blood cells is less in our body and 6000-8000 per millilitre of blood. White blood cells are round, colorless and with nucleus. Generally they live 12-13 days. If we take exercise it will live more and the number will also be increased. White blood cells kill germs by surrounding and digesting them. Therefore physical efficiency becomes strong.

c) Platelets: Platelets also known as thrombocytes, are disc like structures that help stop bleeding. They are the smallest form of elements. If a blood vessel is cut, platelets stick to the edges of the cut and to one another, forming a plug within 3 minutes.

6. Respiration: During taking part in games and sports the rate of respiration increases. As a result of this, oxygen absorption and the removal rate of carbon dioxide increase. The expansion of respiration also increases. Therefore physical efficiency increases.

7. Muscle: There are different types of muscles in our body. The number of muscle fiber does not increase but the size of the muscles increases, tissue

becomes thick and strong. So this improves physical efficiency. Many changes take place due to the effect of exercise that helps in improving physical efficiency.

Activity-1: What changes in heart take place due to physical exercise? write on poster paper and hang it on a wall.

Activity-2: Explain what changes in red blood cells & white blood cells take place due to physical exercise.

Lesson-5: Exercise to Improve Speed, Strength, Endurance, Agility and Flexibility for Physical Fitness

Everyone should have knowledge about their own body before taking any physical exercise. This is essential for the sake of maintaining health. The knowledge about organs and systems helps one to select required physical exercise to develop the organs. By taking appropriate physical exercise we can develop our body to its optimum level. Physical fitness depends on five components namely-

- 1) Strength
- 2) Speed
- 3) Endurance
- 4) Agility
- 5) Flexibility

1) Strength: Strength is the ability to overcome resistance or act against resistance. For example, by developing muscles of hands we can increase strength of the hands. Some physical exercises to develop strength of hands are as follows.

- a) Move dumbbell up and down, closing hands.
- b) Lie in supine position and push barbell up and down with hands.
- c) Put hands on floor parallel to shoulder and push up and down. Slowly raise one leg and push up.
- d) Throw the medicine ball.

e) Different types of exercise of hands in multigym. We can develop strength of hands and shoulders by doing above mentioned physical exercises systematically as per instruction of the trainer.

2. Speed: Speed means quickness of movement. The faster one move, the more speed one has. We should take physical exercise to improve strength of leg muscles in order to gain speed.

a) In supine position move your legs up and down.

b) In gymnasium move the iron weight in and out, using legs.

c) Practice 25 m and 50m sprint again and again.

d) Practice running, using treadmill.

e) Run on sand to strengthen muscles. If we practice above-mentioned physical exercises, it will ensure strength and growth of leg muscles. So, it increases our speed.

3. Endurance: Endurance is a must for games and sports. It is to mention that games like football, long distance run, marathon, basketball etc require high level of endurance. Here are some physical exercises to develop endurance.

a) Run slowly and continuously for a long time.

b) Run across uneven places.

c) Run one kilometer on the 1st day, one and half kilometers after 3 days and 2 kilometers after 7 days. Gradually increase the distance. Any student by acquiring (5) five virtues can develop physical fitness and these increase concentration to studies.

4. Agility: Agility is the ability to perform a series of movements in rapid succession with balance of body in a small area. The following physical exercises can improve agility.

a) Run fast and stop with whistle.

b) Practise 10-meter shuttle run. Do this exercise for a specific period.

c) Practise 20-meter shuttle run for two minutes. The one who can run for the highest number will be the champion. Thus agility will be improved.

5. Flexibility: Flexibility refers to the ability to achieve one extended range of motion without being impeded by excess tissue. The following physical exercises are important to develop flexibility of our body.

- a) Stand up on a bench with your legs straight bend your forward slowly keeping hand attached to ears the one whose body bends more than other is more flexible.
- b) Lie in supine position, keep hands closer to the ears and fold legs at knee and move the body up and down. It is called aching.
- c) Sit on the ground keeping your legs straight and try to touch your toes while your hands are attached to the ears.

Activity-1: Write down the physical exercise in a poster paper and hang it on wall.

Activity-2: Write down the exercises of increasing endurance sequentially and explain.

Exercise

Multiple choice questions

1. Where are the red blood cells produced?
 - a. in the spleen
 - b. in the liver
 - c. in the bone marrow
 - d. in the lungs
2. Which sports require breath and rapidity?
 - a. Cricket
 - b. Volleyball
 - c. Football
 - d. Handball
3. Which of the following happens to our body when we breathe continuously?
 - a. Carbon dioxide comes out of the body.
 - b. Germs in the blood are destroyed.
 - c. The number of red blood cells increases.
 - d. Big cells of the body get broken.

Observe the chart below and answer questions 4 and 5.

Serial no	A	B	C
1	Blood freezes in 3 minutes	damage in spleen after 120 days	Lives 11 to 13 days
2	Oval	Oxygen transportation	Destroys the enemy

4. Whose characteristics do the column A indicates?
- Red blood cell
 - White blood cell
 - Platelets
 - Plasma
5. In the above chart the dissimilarities between column B and C are -
- Differences of colour
 - Presence of nucleus
 - Increase of age

Which one of the following is right?

- i & ii
- ii & iii
- i & iii
- i, ii & iii

Observe the images below and answer questions 6 & 7.



16 years old Rupom



16 years old Sohel

The images show that Sohel's pulse rate is more than Rupom's pulse rate.

6. What is the cause of Rupom's normal pulse rate?
- Young age
 - Study
 - Having nutritious foods
 - Sports

7. Though both of them work hard, why does Soheli get more tired?
- Soheli's platelets increase.
 - Soheli's white blood cells decrease.
 - Soheli's platelets decrease.
 - Soheli's white blood cells remain inactive.

Creative Question

Read the stem and answer the questions below:

1. Two friends, Abir and Arif of class nine participate in Kabaddi and basketball in the sports competition of the school. Abir does well in Kabaddi but he does not play well in basketball as his hands lack strength. On the other hand, Arif displays excellent skills in both games.
- What is strength?
 - Why are there differences of the physical education activities of the boys and the girls during adolescent period? Describe.
 - Explain how Abir can do well in basketball.
 - Will Abir perform well in basketball if he increases the strength of his hands? Analyse.

Chapter Three

Mental Health and Fatigue

We need to know the definition of health before discussing mental health and fatigue. Usually by health we mean physical healthiness or a state of body free from any diseases. But in a broader sense, mental health is also necessary beside physical health. Mental health is largely dependent on physical health. Whatever may be our business, we do not feel good and motivated to work and also our performance falls if our body is not fit. Mental fitness is maintained through harmonious coordination between personal and environmental demands. Thus, an individual who can maintain a good balance between personal demands and social demands successfully is called a mentally fit person. It is the mental health of an individual that shows full and harmonious coordination between physical and mental activities of the whole personality. Temporary fall in performance capability is seen in an ordinary person or an ordinary player as a result of excessive workload or stress. Again, as a result of prolonged engagement in the same job, people experience changes in physical and mental behaviors toward the job. Consequently, the performance capability of individuals decreases. This change in a person's physical and mental state is commonly called tiredness or fatigue.



Mentally healthy children vs. fatigued children

At the end of this chapter we will be able to-

- explain the role of mental health for healthy lifestyle;

- describe the nature of mental behaviors;
- explain human behaviors depending on different situations;
- explain different ways of reducing mental stress;
- explain the concept of fatigue and its various categories;
- explain causes of being fatigued and its consequences;
- describe the means of removing fatigue;
- be habituated in healthy lifestyle by removing fatigue.

Lesson-1: Mental Health and its Importance on Students

Generally, mental health means "full and harmonious functioning of the whole personality". Games and sports help to keep our body and mind fit by maintaining physical as well as mental health. As malfunctioning of an organ of body creates physical illness so is the case with mind. When mind does not function properly, it is called mental illness. In the context of games and sports, the students develop competitive attitudes and consequently they suffer from mental illness. Games and sports require not only physical exercise but they are also the causes of happiness of victory and pains of failure. Since sports men maintain physical fitness, they are required to be mentally fit as well. Physical health and mental health are complementary to each other. Once a student wins in any sports competition, he/she becomes more confident to do better in future events. With a view to retaining this success and performance, they now spend more time for training and practice, and thus become more hard-working. As a result of such victories, the winner may develop negative attitudes such as over-confidence, proudness and tendency to belittle others. Therefore, there may be both good and bad results of a player's competitive attitudes.

On the other hand, when a player experiences defeat in any competition, it creates disappointment and he/she tries to accuse others for the defeat. Many players may give up playing as a result of utter disappointment and mental tiredness. If a player cannot take the normal phenomenon of 'win and loss' of any competition easily, there appears inconsistency in their activities because of mental stress. So, sports teachers or trainers should work together and try hard to maintain mental health or mental balance of the players and students.

Activity-1: A group of students will write on the board how physical fitness impacts upon the state of mind and then will discuss. Another group will write on the board how physical illness affects mind and then will discuss.

Activity-2: How does victory or defeat in a competition affect and influence a player? Students will write it at home to discuss in the classroom next day.

Lesson-2: Mental Behavior, its Classification and ways of Removing Mental Anxiety

Human beings, pass through various biological steps before their maturity. These steps are childhood, puberty, youth and old age. At each stage when physical changes occur, every human is influenced by specific types of behaviors. These types of behaviors are controlled by direct action and chemical stimulants. Besides this, such behaviors are also influenced and instigated by reflex actions and inherent reactions. So, as life proceeds there appears complexity in the nature of behavior and humans solve all the complexities by dint of natural intelligence, reasoning and power to achieve the targets.

Classification of mental behaviors: There exist wonderful dissimilarities between individuals' characteristics and behaviors. For example, someone is extremely jolly but another is sad; one is fond of fun but one is grave; one is lively but another is serious; one is intelligent but the other is dull; one is cautious but the other is adventurous; one is soft and polite but the other is rough and rude. There are numerous examples of such contradictory characteristics which vary from individual to individual. When these characteristics are evident in a person, they are regarded as personal characteristics. By means of this personal uniqueness, one person can be distinguished from another. We need to know the reasons of this personal uniqueness. It is found that all the children who were born and brought up in the same environment of a family do not share the same characteristics. They differ in their personality types and behaviors. Some scholars say that these differences are due to physical structure but some others think that due to genetic uniqueness or environmental condition all these differences in personality occur.

Ways of removing mental anxiety: By health we mean physical and mental fitness. Body and mind are complementary to each other. If there is mental unhappiness, it naturally affects physical health as well. Mental illness may cause lots of failure and distress in human life. Mental illness may initiate mental perversion in children. That's why parents and guardians should be careful to remove anomalies from children's behaviors.

State of mind is the subject matter of mental health. It includes psychology, mental diseases, herbal, socialogy botany, zoology, etc. Child psychology and education, and mental health science help to prevent different types of mental anxieties, mental perversions and disorder. Mental disorder includes mental diseases, shortage of intellect, neurosis, obsession, mental morbidity, crime-proneness etc. In order to remove or prevent mental anxiety from children, proper education for them, bringing them up in a healthy style, good care, good family environment and positive attitudes of parents are essential. Again, patient behavior with children, education for them, child-friendly environment, nutrition, care, and all other facilities necessary to live a happy life should be available with a view to managing complex nature and mental anxieties of children.

Activity-1: In groups students will discuss and show arguments on the subject of contradictory behaviors and characteristics visible in human personality.

Activity-2: In groups students will make a presentation and discuss harmful aspects of mental anxiety and ways to remove it.

Lesson-3: Fatigue, its Classification and Effects on Students

It is usually seen that when someone is engaged in the same job for a long time, there occur physical and mental changes towards the job. The person who experiences physical and mental changes towards the job also naturally experiences a fall in their performance. This physical and mental change is known as tiredness or fatigue. So, fatigue refers to sloth in the working persons

and reduction in their performance. Reduction in performance of individuals is the universal cause of fatigue. Psychologists have defined fatigue in various ways. Some said, "Reduction in performance is fatigue." Another defined, "In work situation a fall in working capacity or performance is fatigue" An analytical definition is, "As a result of continuous engagement in the same type of job for a long time, there appears a decrease in working capacity of individuals and this decrease of working capacity may be termed as fatigue."

Classification of fatigue: Psychologists have classified fatigue into two categories: a) physical fatigue, and b) mental fatigue.

a) Physical fatigue: The fatigue that occurs because of physical labour for a long time is called physical fatigue. This type of fatigue is related to body muscles and senses. Every individuals has got a limit or borderline of their capacity to work or labour and when they cross their limit, fatigue occurs. In normal situations, the body fulfils all the physical needs required at work. For example, body meets the demands of additional oxygen by breathing quickly. Again, in case of rise in blood pressure and heart beat, body discharges additional starch. But fatigue occurs in an individual when the job is highly labourious, or if the person is less endurable, or if the physical balance is affected due to very cold or hot weather.

b) Mental fatigue: Mental capacity decreases and fatigue occurs when someone does any mental work for a long time. For example, if we solve mathematical problems for a long time, we see that our thinking power, logical power and power to correct the results of the problems gradually fall and thus we experience a decrease in our mental capacity. This change of mental state or decrease of mental capacity is known as mental fatigue. Besides, fatigue may also occur due to differences in personal likings and change in mental condition, and environment. As physical and dislikings mental work cannot be isolated fully, so is the case with physical and mental fatigue. Therefore, mental fatigue may occur as a result of long physical activity and similarly, physical fatigue may be caused by long mental work as well.

Effects of mental fatigue upon students: The physical fatigue that occurs in students participating in physical education programmes depends on the volume of physical activities they do. As a result of physical labour, huge amount of sweat is discharged from their body and it has impact upon movement of body-organs and concentration in the activity. While performing physical

education programmes, the students often suffer from mental fatigue which is visible through the following symptoms:

1. They may make mistakes in their performance of physical education programmes.
2. They may lose self confidence.
3. There are lackings of coordination in their activities.
4. They lose rhythm of work and take wrong decisions.
5. They become inattentive and cannot understand the techniques of implementing the programmes.
6. There decreases attentiveness to duty and they become mentally weak.

Activity-1: Students will write on the board and discuss what fatigue is and what factors cause fatigue.

Activity-2: Students will prepare a list of the effects of mental fatigue on mind and then they will discuss in groups.

Lesson 4: Causes of Mental Fatigue and their Remedy

Whatever may be the fatigue either it is physical or mental there must have some reasons behind it. We have just discussed the causes of fatigue occurring in human beings due to programmes related to physical stress. There are many other reasons why fatigue may occur. Psychologists have divided the causes of fatigue into three classes: 1) causes related to body or physique, 2) causes related to mind or psyche, and 3) causes related to environment. Causes of physical fatigue include generation of lactic acid in muscles, decay of body muscles, discharge of salt from body, significant shortage of oxygen, excessive body movement etc. In this lesson we will discuss mental fatigue. We can analyse the causes of mental fatigue in the following manner.

1. Lack of mental preparation: We should be mentally prepared before doing anything. If the performer does not have clear idea about the activity, fatigue may occur more quickly than usual.

2. Lack of practice and habit: If the students practice the programme regularly and get habituated to the activities required for the programme, fatigue will not occur soon. Thus, fatigue occurs due to lack of practice and exercise.

3. Lack of motivation and love for work: When you are motivated and you love the work, fatigue does not occur even after you have worked for a long time. On the other hand, where there is no motivation, the work becomes simply a burden. In such coercive work, fatigue appears very easily.

4. Lack of mental willingness: If a student is unwilling to implement any activity fatigue occurs quickly. Strong willpower make difficult tasks easy. Hence, lack of mental willingness is considered as one of the causes of fatigue.

5. Environmental causes: Apart from physical and mental causes, there are some factors that may cause environmental fatigue. Unhealthy environment e.g. damp and shabby environment, too hot, too cold or damp weather is not congenial for any work. In such an environment there is high probability to get fatigued. In the same way, lack of adequate light, air, wide space and clean environment creates fatigue among the workers.

Ways to remove mental fatigue: As loss of physical and mental strength is the root cause of fatigue, fitness and energy of the both can remove it. In order to remove mental fatigue, we can put emphasis on the following issues:

1. Generating love for programmes: When the students love physical education programmes, fatigue cannot overpower them easily.

2. Avoiding monotony of programmes: The monotony of boring activities makes the students fatigued. On the contrary, a little rest in work makes activities enjoyable and effective by removing monotony and fatigue.

3. Motivation: Activities should be full of motivations and it will ultimately lead to spontaneous participation in the activities. Thus, motivations can remove fatigue.

4. Avoiding stressful programmes: Students should not be compelled to implement any activities that go beyond their capability.

5. Rest and sleep: As nutritious food essentially prevents physical decay, similarly rest and sleep help to remove fatigue and tiredness. Rest and sleep remove physical and mental fatigue and thus people can work with new enthusiasm and fresh energy.

Activity-1: Students will prepare a list of the causes of mental fatigue as homework. In the classroom, they will write the causes on the board and discuss in groups.

Activity-2: Write serially the ways of removing mental fatigue and present it in the class. Then discuss the subject.

Exercise

Multiple choice questions

1. What is fatigue ?
 - a. Decrease working ability
 - b. Physical weakness
 - c. Lacking of energy towards work
 - d. Nervous weakness
2. If defeat in sports is not taken lightly -
 - i. It creates mental stress.
 - ii. Inconsistency in work is observed.
 - iii. Negative mentality grows up.

Which one in the following is correct?

- a. i & ii
- b. ii & iii
- c. i & iii
- d. i, ii & iii

Read the passage below and answer questions 3 and 4.

Shamim is a student of class eight. Both his parents are job holders. As there are no fields beside Shamim's home, he does not participate in sports. He becomes depressed.

3. Reason for Shamim's illness -
 - a. Physical
 - b. Mental
 - c. Familial
 - d. Social
4. The way to get over Shamim's present condition is -
 - i. Arrange entertainments
 - ii. Company of friends
 - iii. Participate in games and sports

Which one in the following is correct?

- a. i & ii
- b. ii & iii
- c. i & iii
- d. i, ii & iii

Creative Questions

1. After the sudden death of her father, the responsibility of running the family along with her younger brother's education and treatment of her mother comes upon Ritu, a meritorious student of class nine. So, by tuitions in the morning and in the evening and by sewing cloths at a tailor's shop at night, she earns money. Her confidence breaks down because of her poor results in the annual examination of the school. For this, she decides to leave study. But the encouragement of her mother and the school teachers brought her back to study.
 - a. What is motivation?
 - b. What is the reason of abnormality in the child's mind?
 - c. Explain the reasons of Ritu's poor results?
 - d. What factor do you think works to remove Ritu's mental problems away? Present logically.
2. Nilima practised mathematics for the whole day. In spite of her mother's request to go outside, she didn't go. In the evening, Nilima became tired. The mathematical problems, which she could solve in a little time at day, are now taking a long time. Nilima is worried about it. Her mother tells her to take a break for a while and watch television.
 - a. What is mental fatigue ?
 - b. Explain that body and mind are complementary to each other.
 - c. What causes Nilima to take a long time for solving mathematical problems at night? Explain.
 - d. Analyse the appropriateness of Nilima's mother's suggestion to overcome her situation.

Chapter Four

Health Science and Health Service

The branch of Medical science that discusses and analyses scientific ways of living individually and collectively is generally called health science. Let's start with a famous quotation from Socrates. In the "Republic" Plato quoted that Socrates said "Now to produce health is to part the various parts of the body in their natural relations of authority or subservience to one another, whilst to produce disease is to disturb this natural relation". If we simplify this definition we understand that health means physical fitness or healthy state of body. But in broader sense only physical fitness does not mean health; it also includes mental health. In order to be healthy we should have apt knowledge about health science. Health science gives us ideas about how to maintain health and it also shows the way how to get rid of diseases. Health science gives us a clear idea about health services, so we should identify the common health problems and be aware of maintaining individual and collective health. We still develop healthy environment at school and at home. School Tiffin programme to fulfill under-nutrition and regular health service programmes at schools will play a significant role as complementary to student's education.



At the end of this chapter we will be able to–

- explain the importance of health science;
- explain concept and techniques of maintaining personal health;
- take preventive steps for common health problems;
- explain the coverage of health services;
- describe the necessity of Tiffin programme at school;
- have an idea about health card and explain its usefulness to motivate others in preventing diseases.

Lesson 1 : Health Science and its Importance

The objective of the study of health science is to have knowledge about health and its principles. Again the objectives of following health principles are to prevent diseases, The more we find out the reasons of diseases, the more we will be able to prevent them. The ultimate objective is to get rid of diseases and has a long healthy life. Therefore by studying health science we can learn how to have good health and long life. We should acquire knowledge of health science to understand the essence of the proverb "health is the mother of all happiness." Environment and society have influence on our health. Dirty environment causes harm to our health. Communicable diseases cause contamination from one body to another. How germs of communicable and contagious diseases are transmitted from one person to another and what we should do to prevent such diseases, are all the topics covered under health science. Health science provides us knowledge about drinking safe water, avoiding polluted air, eating nutritious balanced diet, living in a well-lit and well-ventilated house, keeping school building healthy, travelling safely, ensuring self-defense from ferocious animals, like mad dogs and mad foxes, managing sewerage and garbage etc. Prevention and cure of diseases are two major objectives of health principles. But prevention of diseases and nature of prevention depend on types of diseases. For example, different diseases like cholera, T.B. pox, typhoid, etc. require different

preventive measures and curative treatment. Polluted air, water, rotten, stale and open food, problems in managing domestic garbage and sewerage and dirty environment contribute to the spread of all these diseases. Similarly two major aims of health policy are reduction of the death rate of mothers and children through better management and medical facilities, and ensuring "First AID" for accidents. The main barrier to build good health is ignorance of indifference to health instructions. Proper education, wide publicity for good health etc, play an important role to remove this barrier. We should remember that every individual is a member of the society they live in. So, people at every sphere of society should be aware of health science. They should be advised to follow the principles of good health for collective welfare.

Activity-1: What do you understand by health and health science? Write these separately and present in the class.

Activity-2: Pure water and air save our life but if that water and air are polluted, they also spread diseases. Discuss elaborately and explain with relevant examples.

Lesson-2: Concept and Technique of Personal Health Care

Physical fitness is a precondition for happy life. When a student is not physically fit, he/she can't concentrate on study and do not find interest in any activity. So they cannot accomplish any task properly. It is essential to keep oneself physically fit in order to do anything successfully and live in peace and happiness. It is difficult to restore a person's health to its healthy condition. To lead a healthy life everybody should take care of health and follow health instructions. **What is health care?** Health care refers to maintain physical structure and natural growth and keeping free from diseases. The personal health care includes being aware of one's own health, taking necessary measures of health care and following all health instructions. The issue of health care is related to both physical and mental health. An individual's

physical growth and mental development take place, starting from childhood until youth. During this period they have to follow age-specific health instructions. So besides maintaining physical health, we should maintain mental health relationship as the mind and the body are complementary to each other.

Techniques of personal health care: We should develop health habits to live a healthy life. The foundation of developing health-friendly habits is following health related rules. Health rules include cleanliness of oneself and their house, schools, surroundings, roads etc. necessary and adequate physical exercises, rest and sleep; sufficient intake of balanced diet and regular participation in games and sports. We can keep our body and mind fit by following these health rules. One of the main aspects of health care is doing all necessary tasks related to health in time. A basic means of maintaining mental health is keeping oneself cheerful and perky. In this regards recreational activities such as playing games, travelling, practicing cultural activities, observing religious activities etc. are important. Punctuality is also one of the important issues of maintaining health. We should complete all activities in right times. Habit of regular and natural exertion, keeping away from drugs etc. are some important techniques of maintaining personal health. Knowing the techniques of maintaining personal health and following them are very essential to lead a healthy life.

Activity-1: Fill in the table below with activities rules and instructions relating to physical and mental health care.

Physical health related activities/rules	Mental health related activities/rules
1.	1.
2.	2.
3.	3.
4.	4.
5.	5.

Activity-2: What do you do for personal health care every day from early in the morning to bed time at night? Show them in the class through action.

Lesson-3: Common Health Problems and Remedies

Disease or sickness is part of life. None can live without any disease in life. But one can avoid and prevent diseases. Common health problems leads to sickness. Therefore in order to keep oneself free from disease, one should know about the nature of a disease, its germs and how the disease spreads.

Causes of diseases: Various types of germs cause various diseases. We come into contact with a lot of germs of different diseases every day. The germs enter our body in many ways. When the immunity of body decreases the body cannot fight against germ attacks and it becomes sick. On the other hand, germs can not easily attack the person whose body is strong and stout remains healthy.

Nature of diseases: There are some diseases that infect other nearby people. Such diseases are called communicable diseases. Apart from human body, diseases can be transmitted through other objects like water, food, air, etc. Some communicable diseases causing health problems are cough and cold, eye infection, diarrhoea, influenza, whooping cough, diphtheria, measles. pox, malaria, tuberculosis, typhoid and jaundice. Diseases that are not transmitted from one person to another are called non-communicable diseases. For example, cancer, high blood pressure, diabetes, etc. are some non communicable diseases.

Common health problems: We have so many health problems in our country. Despite control in pox and malaria, the outbreak of cholera, typhoid, dysentery and many other stomach diseases has spread widely. Malnutrition, lack of safe water, health issues. homelessness, shortage of doctors, unavailability of medicine, high mortality rate of mothers and infants and unawareness of personal healthcare etc. have made common health problems more complicated.

Remedies for common health problems: Self-awareness plays the most important role in preventing diseases. We should always be careful so that germs of diseases cannot be communicated. We should take all possible measures of personal health care to keep our body free from diseases. Our immune system become stronger when our body is healthy and strong, We must know the ways of preventing each and every disease if we have to prevent communication of germs. There are specific ways to prevent specific diseases. But some common measures can help us to prevent spread of most of the diseases. They are-

- 1. Vaccination:** Children and adults should take vaccines for those diseases which can prevented by the vaccines. Diseases that can be prevented through vaccines in our country are pox, typhoid, tuberculosis, influenza, polio, diphtheria, whooping cough, tetanus, measles, hepatitis, etc.
- 2. Personal cleanliness:** We should always maintain cleanliness of our own body, clothes, furniture, kitchen utensils, crockery, living places, bathrooms and surroundings.
- 3. Habit of washing hands with soap:** We should wash our hands with soap every time after using toilet , before cooking and serving food, before taking food, after nursing sick people, after cleaning stool and urine of children and each time after returning from outside.
- 4. Cooking, preserving and serving food:** We should take care in cooking, and the preservation and service of food. It is very essential for us to prepare food in a healthy way, to be careful about food preservation and to cover food all the time.
- 5. Pest and insect:** We should consider issues of remaining careful about pest and insect attacks, drinking safe water and washing with it etc as remedies for common health problems. Usually the spread of diseases takes place due to our ignorance and carelessness about health, which causes many deaths in our country every year.
- 6. Awareness building to prevent diseases:** We should build extensive public awareness about prevention of diseases. So public awareness can be raised by means radio, television, poster, cinema, newspaper, public speech etc,

Activity-1: Fill in the following table by making a list of five persons from your family and people you know who were attacked by diseases last year.

Name of the Persons	Name of the Diseases they suffered from last year	Which one is	
		Communicable	non communicable
1.			
2.			
3.			
4.			
5.			

Activity-2: Select three tasks from your daily household activities (e.g. cutting fruits, cooking food, boiling water, sweeping and wiping floor) mention measures to be taken to prevent them from contamination

House hold activities	Measures to prevent contamination
1. Cutting fruits	1.To wash fruits in safe and pure water. Clean knife well to keep cut fruits in clean pot and cover them.
2.	2.
3.	3.

Lesson-4: Students Health Service and Health Cards

People who go to educational institutions to gain knowledge are known as students. Students stay at school from 6-16 years. They have to stay at school for 7 to 8 hours a day, 6 days a week and 7/8 months a year. The time of their stay at school is highly important for them to grow as good citizens of the country. School should give special attention to the health of the students for their all-round development. If the environment, furniture, teaching materials etc are congenial for students' health, their body and mind will develop properly. School is the best place for mental development and building moral character. Students acquire good qualities under the guidance of an ideal teacher. Similarly for all round physical development with good environment, clean school building, pure water, nutritious mid-day school meal, healthy sanitation system, classroom with sufficient light and ventilation, open play ground and gardens is called healthful school. Following areas should emphasize the better health service of students-

- a) **School building:** School building should be located in such an open place where light and air can enter from all sides and where people can move easily.
- b) **Playground:** Student life without games cannot be imagined. There should be a play ground adjacent to school. So that students can participate in various games and sports throughout the year.
- c) **Healthful sanitation system:** There should be arrangement for healthful sanitation little away from school building and there should be sufficient supply of water.
- d) **Pure water supply:** The supply of pure water is one the components of health service. In towns people should boil supplied water before they drink it; in villages the water of deep tube wells is pure and people can drink it directly. Water from any other source like ponds, river, etc, should be boiled before drinking.
- e) **Classroom and furniture:** Necessary steps to be taken so that classrooms and furniture are not unhealthy.

- f) **School Health Programme:** School Health Programme is a very important issue to ensure health service for students, Students are attacked by various diseases in summer, rainy session and winter. Precaution in this respect helps to keep away from those seasonal diseases. Students can remain free from common diseases through participation in school health programmes.

Salient features of School Health Programme are as follows:

Regular Medical examination of students: Every school should have a systematic medical examination of students, first aid facilities and healthful school environment. A doctor can work as a inspector of this programme. Under the supervision of civil surgeon of each district health inspector can examine student's health and advice treatment for different diseases.

School authority will help the school's inspector with all possible assistance. The health inspector will examine age, weight, blood group, blood pressure, pulse rate, physical structure, eyes, teeth, heart, lung, etc of each student and record them in a card. This is called student health card.

Health Service Centre: Where there is no school health programme a general teacher should be given training on health service to solve common health problems. If a student is seriously sick they can be sent to the nearest health service center or be admitted to hospital. At present one can get health service from the union health and family welfare center, upajila complex, district sadar hospital or a specialized hospital.

Students health card : A health card is a thick paper with health related information printed on it.

The health card will carry the following information.

Name & address of school

Sample Health Card

1. Name of Student

2. Name of father/Name of mother

3. Address

4. Date of Birth ----- Age

5. Class ----- Roll no

6. Height ----- Weight

7. Body Structure

8. Blood pressure

9. Eye/Nose/Ear/Throat/Lung/Heart

10. History of sickness

11. Present health problem

12. Next date and time of medical examination

Signature of health inspector

Activity-1: Students will write about a discussion of a healthful school building and present in the classroom.

Activity-2: Make a list of the tasks of a school health inspector and prepare a sample health card and students discuss in groups.

Lesson-5: Midday School Meal for Students

World education conference 1990 was held in Jomtien, Thailand focusing on the universal education. Based on the decision of the conference a programme named 'Education for all' was launched. According to the programme, a policy was declared that all the participating countries would take necessary initiative to make primary education compulsory. It set its target to remove illiteracy from their respective countries. Without education at primary level most of the children will not be able to read and write. As a result a country will not be able to come out of the vicious circle of illiteracy. Backwardness in primary education seriously affects the education at secondary level. In Bangladesh a majority of its population is poor and they live in rural areas. Schools in rural areas are not able to fully implement the education for all programmes as declared by government. Dropout rates in this schools are high and they cannot complete the course of education fully. There are many reasons for this situation. One of the reasons of the dropout problem is that during their stay at school most of the students remain hungry. They cannot concentrate on study in the classroom. The school authority has taken initiatives to get rid of this problem by launching the mid-day school meal programme.

The majority of the people of Bangladesh are poor and they cannot afford sufficient food for their children. Many of the students come to school half-fed or unfed. They suffer from malnutrition, cannot concentrate on study and are affected by other problems.

To solve this problem the mid-day meal programme for students has been introduced in schools.

Objectives of mid-day meal programme : Some of the main objectives of this programme are as follows.

1. To mitigate hunger during school time.
2. To prevent dropouts and to increase the number of students gradually.
3. To enhance interpersonal good relation and friendship, co existence, sympathy among students inside and outside classroom.
4. To prevent malnutrition and participate in different health programmes.
5. To participate actively in games and scout programmes.
6. To remove pressure of providing food for children of the poor guardians and ensure their regular attendance in the classroom.

Healthy Tiffin: A student has to stay at school for 7-8 hours. Naturally they get hungry during this long period. They can concentrate on their lessons if they can gratify hunger during this time. It helps them remove fatigue and tiredness. As a result of this programme their standard of education goes up. The higher the quality of the tiffin the better they will feel physically and mentally. Hence the school authority has to arrange nutritious tiffin regularly. Through implementing mid-day Tiffin programmes for students, education for all programmes will be carried forward, literacy rate will be increased and finally it will contribute to building a strong nation.

Activity-1: Asked by the teacher students will write on board the main obstacles to fully implementing “Education for all” programme. Then students will be divided into two groups and show their arguments for and against.

Activity-2: As homework, students will write the main objectives of mid-day school meal/tiffin programme with arguments and present them in the classroom.

Exercise

Multiple choice questions

1. What is health care?
 - a. Sleeping more
 - b. Remain free from disease
 - c. Enjoyable journey
 - d. Taking foods with fat.
2. The purpose of following health rules is -
 - i. To protect oneself from the attacks of diseases.
 - ii. To follow a healthy routine.
 - iii. To eat more

Which one of the following is right?

- a. i & ii
 - b. i & iii
 - c. ii & iii
 - d. i, ii & iii
3. The purpose of tiffin program in schools is -
 - i. To increase the attendance of students in schools
 - ii. To create meritorious students.
 - iii. To develop the standard of education.

Which one of the following is right?

- | | |
|-------------|----------------|
| a. i & ii | b. i & iii |
| c. ii & iii | d. i, ii & iii |

Read the stem below and answer questions 4 & 5.

The Upazilla Education Officer during his inspection of the school in Sonapur village saw that the rate of absence is high. The Head teacher informed him that most of the students of that area are poor and suffer from sickness. There is lack of pure water in this village. The Education Officer discussed the matter with the management, arranged to plant a tubewell in that area and also conducted campaigns to raise mass awareness about the means of purifying water.

4. What kind of disease are the students of Sonapur village suffering from?
- | | |
|--------------|-------------|
| a. Diabetes | b. Asthma. |
| c. Diarrhoea | d. Anaemia. |
5. Which one of the following is helpful to protect the students from this situation?
- | | |
|----------------------|---------------------------------------|
| a. Health awareness. | b. Increase the standard of education |
| c. Take costly meal | d. Development of the environment. |

Creative Questions



1. Conversation between two persons -

Fuly: Would you get flowers, sister, flowers? Only ten taka for one bunch.
Please, take one sister; I will have rice.

Antora: Come here. (after buying the flower), Why don't you go to school.
Don't you have any parents?

Fuly: We have no food to eat- how can I go to school!

Antora: (showing the picture of Mina cartoon) Primary education is free. There is also an arrangement for mid-day meal at school.

- What are the fundamental topics in maintaining mental health?
- What is meant by personal health rules?
- Explain the reason why Fuly does not go to school.
- Is it possible to implement successfully the "Education for All" programme by keeping the hungry children at school? Explain.

2. Nilu and Adiba are two friends. They are in class nine.



Adiba's home



Nilu's home

Adiba comes to school regularly, but Nilu is often irregular. After a long absence when she came to school the teacher wanted to know why she was absent for such a long time. In reply she said, 'she often had a pain in the abdomen along with vomiting and diarrhoea'.

- What is the pre-condition of a happy life?
- How can the dropout of students at school be prevented? Explain.
- What type of disease attacks Nilu? Explain.
- Which factors act in favour of Adiba's being sound? Analyse according to the stem.

Chapter Five

Nutrition for Health

We need to understand what health is. Generally, by health we mean physical fitness or keeping free from diseases. But in a broad sense only physical fitness is not the parameter of healthiness as mental health is also important. So physical and mental fitness together make healthiness of a person. Human beings need food to live, maintain health, and physical development. The food should be full of nutrients. The foods that keep our body healthy and strong is called nutritious food. Balanced diet supplies nutrition to body. Balanced diet includes those items of food in which all ingredients of food are available in proper proportion and quantity.



Balanced diet

At the end of this chapter we will be able to—

- explain concept of nutrition and its necessity for students;
- explain the necessity of nutrition for players;
- explain the concept of malnutrition and its effect on humans;
- explain the effects of malnutrition on games and sports;
- prepare a list of food with required calorie for different age-groups;
- take cautionary measures to prevent food contamination.

Lesson-1: Concept of Nutrition and its Importance

At puberty the adolescents experience very quick physical development. To support this physical growth and development they need adequate nutrition. They should take proper quantity of food with all necessary ingredients to supply energy, repair decay and to prevent diseases at the growing stage. Lack of nutritious food causes mental and physical retardation and reduces immune system. Therefore compared to other stages of life, people need more nutritious food at puberty. At this age children remain busy with study, games and sports etc. Due to their physical activity they need more calories. The intake of low calorie food hampers physical and mental development.

Food ingredients: There are a number of ingredients of food namely protein, carbohydrate, fat, vitamin, minerals and water. Any food rich in any of the ingredients is known as such, for example any food that contains protein is known as proteins and the food that contains carbohydrates is known as carbohydrates.

Sources of nutrients and its functions: Protein is necessary for body building, development and growth of body and to repair physical decay. Proteins are required for body energy and immunity. Fish, meat, milk, eggs, cheese, curd, pulses, beans etc are common sources of proteins. Carbohydrates are the main source of energy for all activities. Rice, wheat, corn, potato, sugar, honey, arum roots, sweets etc are sources of carbohydrates. Fats generate heat and energy for body. Butter, ghee, fat, soya bean, milk, fish oil, coconut oil etc are the sources of fat. Vitamins are essential to prevent diseases, maintain different activities inside the body and protect it from decay. Fish, meat, egg, milk, mustard oil, fish oil, green and red vegetables, fruits, beans, oil seeds, coarse rice, wheat with fiber, sprouted seeds are the sources of vitamins. Minerals are very important for internal functions of body. There are many minerals in our body and every time they are discharged with urine, stool and sweats, they causes body decay. Some common minerals of our body are calcium, phosphorus, iodine, sodium, potassium etc.

In order to compensate the loss of minerals we take salt, milk, milked food, small fish, meat, yolk, beans, vegetables, pulses, lime, banana, green coconut water etc. 70% of our body consists of water. Water helps in maintaining the body structure, keeps the body cool and active, helps digest food, helps in blood circulation, transpiration of nutrition inside the body and also it helps in exertion. Timely intake of sufficient amount of food is necessary for maintenance and development of body. By appropriate food we mean a

balanced diet. Balanced diet supplies required calories to the body. A balanced diet contains the proper amount of each of the six nutrients mentioned above. The required amount of balanced diet varies, depending on the age of people. For example, the requirement of carbohydrate, protein, fats and other nutrients by an adolescent is higher than that of a child. Therefore the requirement of a balanced diet varies according to age, sex, and body structure.

Activity-1: In the table below column-1 and column-2 respectively show the name of food and their function in the body. Match column-1 with column-2 using arrow:

Column-1	Column-2
Food	Function of food in body
• Rice	• prevent disease
• Colorful vegetables	• fulfill requirement of minerals
• Fruits	• help (s) in blood production
• Iodized salt	• help in physical growth and development
• Arumleaces (leaves)	• help in blood circulation
• Meat and egg	• keeps the body cool and active
• Water	• repair (s) physical decay
• Butter	• helps in exertion
• Pulses	• generate (s) heat and energy

Lesson-2: Causes of Malnutrition and Remedies

We need food to live and maintain health and physical development. Food supplies nutrition to the body. Symptoms of proper nutrition, are enthusiasm and hard work. We need energy to work. Nutritious food supply energy. Six nutrients of food supply energy to our body.

Functions of nutrients: Different nutrients have different functions. Functions of these nutrients include body building, growth and development, repair of decay, heat and energy supply, heat and energy production, development and maintenance of organs, blood circulation, nutrition supply, discharge of urine and stool, cooling of body etc.

Requirement of balanced diet: Foods containing all the six nutrients proportionately are called a balanced diet. But its requirements vary according to age and sex. For example, requirement of proteins, carbohydrates, fats and other nutrients by an adolescent is higher than that of a child. Again, amount of food required by a player/labor is even higher than that of an adolescent.

Malnutrition related diseases: Muscles will decay instead of development in case there is deficiency of proteins in a child's food. Due to protein deficiency fluid volume increases in the body and a child becomes very weak. This disease is known as Kwashiorkor. On the other hand, a child will suffer from a disease called Marasmus as a result of deficiency of proteins, fat etc. Iron, protein and other nutrients produce haemoglobin in blood. Due to deficiency of these nutrients in food a disease called anaemia takes place, Deficiency of calcium, phosphorus and vitamin-D causes children suffer from a disease called rickets. Deficiency of iodine is responsible for Goiter. Deficiency of vitamin-A reduces eyesight at night, which is called night blindness. Beriberi for thiamine deficiency, mouth sore for riboflavin deficiency, scurvy for vitamin-C deficiency are some diseases related to malnutrition.

Causes of malnutrition: The main cause of malnutrition is ignorance and lack of awareness. It is a serious mistake to give fish-head, cream, cheese, big piece of fish and meat to the senior members of the family leaving the growing children aside. Adult people require less protein and fat whereas growing children and teenagers require much more protein and fat in their food. Lack of proper distribution of food according to requirement of specific age group is also a major cause of malnutrition in our society.

Remedy for malnutrition

1. Family heads should know about the low cost food with the same nutrition value.
2. We should avoid superstition and wrong perception about some food such as duck eggs, Boal fish, Gojar fish, pumpkin etc as bad food.
3. Parents should know about necessity of nutritious foods.
4. Parents should know that cooking for a long time spoils food value of many vegetables and greens.
5. Vegetables should be washed before cutting them.
6. Guardians should be encouraged to rear poultry and cows in the house to address the deficiency of proteins.
7. We should try to eat small fish if big fish is expensive.
8. We should prepare a list of food according to food value and select daily meal to ensure nutrition for the family.
9. Wide publicity for nutrition, malnutrition and remedies through radio, TV, and newspapers should be ensured.

Activity-1: Make a list of a balanced diet with the name of low cost food items available in your locality.

Activity-2: Write down on the board some examples relating to causes of and remedies for malnutrition serially and discuss in groups.

Lesson-3: Calorie Requirement of Players According to Age

Food is required to maintain health. Symptoms of proper nutrition includes good health, sound mind, enthusiasm, and hard work. We need energy to work. Any instrument like the cutter, axe, knife, cleaver, etc. grow blunt due to use. Wood erodes and shoes become old and torn out if we use them again and again. But whatever work we do with our fingers and whatever movements we make with our legs, they never become out of order like others. Actually food repairs decay of body and provides energy to work. In short food keeps our body functional and active. Six food nutrients supply nutrition to our body. So food in which six nutrients are present in proper proportion and quantity is called balanced diet. The functions of these nutrients of balanced food are different from person to person according to their age, body weight and nature of work. For example, requirements of proteins are the highest in childhood. Any person engaged in physical labour requires food that produces heat. Pregnant and lactating mothers need more nutritious food than normal women. Again requirement of nutrition is higher at the time of recovery from any diseases than at normal time. A player who participates in games and sports involving huge physical labour needs more calorie than others.

Calculation of calorie and energy: Proteins, carbohydrates and fats produce heat in the body after digestion. Calorie in a food item is measured through measuring heat being produced from that food. Food value is measured in kilocalorie. For example, 250 grams of milk produces 165 kilocalories and a tea-spoonful of sugar produces 16 kilocalories of heat. Heat absorbed in food

keeps body active and provides energy to work. The higher the body weights the more calories the body burns. Required energy is expressed in terms of heat whose unit is kilo-calorie. A list of how much energy is required for doing light, medium and heavy activities is shown in the table below. In this table energy required for sports and running is also mentioned. The amount of calorie loss per hour according to body weight is given below.

Amount of calorie required per kilogram of body weight per hours

Nature of work	Energy (kilocalorie)
Taking bath, wearing dress, eating etc. daily routine work.	3-4
Sitting or Standing up	1.5-1.9
Walking	3-5
Reading, writing, sewing, typing, cooking etc.	1.5-2
Work of a cobbler and moderate work	2.5-4.5
Cutting wood, crushing stone, carting load etc heavy work	5-10
Running , playing games	4-8

Measurement of kilocalorie: What amount of calories one will need to do a specific task can be calculated from the table above. For example, the amount of calories will be burnt for a player with 55 kg body weight to play for two hours is $55 \text{ kg} \times 2 \times 4 = 440$ kilocalories. So amount of calories required to do a job depends on the body weight and the nature of job. Excess amount of calories causes fat accumulation in body. The requirement of calories varies according to sex. Daily calorie requirement for a man and a woman can be calculated multiplying their body weight in pounds by 21 times and 18 times respectively. In order to gain or lose body weight one should take $\frac{1}{3}$ less or more than daily calorie requirement. We should remember that we should ensure calorie intake of daily requirement from three meals of the day.

Age specific daily requirement of calorie

Age	Energy (Kilocalorie)	Protein (gm)	Calcium mg	Iron	Vita-A microgram	Vita- B1(mg)	Vita- B2(mg)	Vita-c mg
1	2	3	4	5	6	7	8	9
Adolescent (13-15) yrs	2500	55	650 mg	18	725 mcg	1.3	1.4	30
	2200	50	650mg	24	725 mcg	1.3	1.4	30
Boys-Girls (16-18)yrs	3000	60	550mg	9	750	1.5	1.7	30
	2200	50	550mg	24	750	1.1	1.2	30
Adult man	2400	55	450 mg	9	750	1.25	1.3	30
Adult woman	1900	50	450 mg	28	750	1.00	1.0	30

Daily requirement of food for growing boys and girls

Type of food	Boys		Girls
	13-15 years gm	16-18 years gm	13-18 years gm
Milk or milk product food	187.5	187.5	187.5
Egg (Three days a week)	1	1	1
Fish-meat	62.5	62.5	62.5
Pulse	62.5	62.5	62.5
Nuts (occasionally)	62.5	62.5	62.5
Fruits	62.5	62.5	62.5
Green vegetables	125.0	125.0	140.0
Other vegetables	187.5	250.0	187.5
Rice	187.5	250.0	187.5
Bread	187.5	187.5	125.0
Potato	62.5	62.5	62.5
Sugar/Molasses	31.25	46.5	31.25
Oil/fat	46.5	62.5	46.5

Activity-1: Make a list of calorie requirement depending on various physical activities.

Activity-2: Prepare a table to show the daily food requirement of growing boys and girls

Lesson-4: Food Contamination, Causes, Symptoms and its Prevention

Everything that repairs physical decay and maintains physical development and heat is called food. Our body is undergoing decay all the time due to physical activities. It is food that repairs this decay and keeps our body active. Of course, all the food items should be nutritious and balanced. Even nutritious food may cause harm to our body if the food is not safe. For example, anybody fall sick by eating contaminated food stuff. Contaminated food becomes poisonous and creates serious threats for health and life. Any contaminated food or drink that causes bacterial infection in the gullet and stomach is called poisonous food or drink.

Causes of food poisoning: Usually food poisoning is caused by bacteria or toxin, a special type of organic poison. Bacteria contamination can occur in many ways. For example, keeping cooked food for a long time, before it is prepared and also during its preparation through harmful pests and insects etc. Again proteins if not properly preserved get rotten and produce toxin. Taking such toxic food items may cause food poisoning. Besides, flesh of poisonous animals, food contaminated by poisonous animals, food prepared with dirty and unhygienic hands, meat of poisoned poultry etc. are also some causes of food poisoning.

Symptoms of poisoning: Food contaminated by bacteria makes stomach upset and as a result, nausea and vomiting, abdominal pain, loose motion and dehydration take place. Food poisoning caused by toxin creates terrible situations. Symptoms like vomiting, constipation, vision problems, palsy, weakness etc. are visible in such a situation. Food poisoning by toxin is called botulism. Symptoms appear within 12-24 hours after taking contaminated food. The patient may die in a few days if proper treatment is not given in time.

Preventive measures we should-

- wash our hands well before preparing food.
- take necessary measures to prevent contamination during food preparation and preservation.
- drink safe and pure water.
- keep cooked food away from raw fish, meat and vegetables.
- preserve our cooked food at appropriate temperature for a certain period of time.
- use safe water in cooking and food related washing.

Treatment: For the nausea or vomiting problem we should take the right medicine. In case of dehydration we should take oral rehydration solution (ORS). In emergency situation caused by food poisoning, should consult doctor and get admitted to hospital immediately.

Activity-1: Write how food poisoning takes place and present the write-up in the class.
 Activity-2: Prepare two different lists on what symptoms appear due to food poisoning and how to prevent food poisoning respectively.

Exercise

Multiple choice questions

1. When does the human body grow rapidly?
 - a. Childhood
 - b. Boyhood/Girlhood
 - c. Adolescent period
 - d. Youth
2. Which one provides work-power in a body ?
 - a. Carbohydrate
 - b. Vitamins
 - c. Minerals
 - d. Fat
3. On which basis does the need of nutrition vary?
 - a. Body formation
 - b. Easily available
 - c. Reasonable price
 - d. Mental growth
4. How does mutton become toxin?
 - a. Due to lack of preservation
 - b. By keeping in the open space for a long time
 - c. By cooking with excessive heat
 - d. By keeping in untidy place for a long time

Read the stem answer the questions 5 & 6.

After school time, Rahimur of class nine take Fusska from a chatpati shop beside the road. A few hours later after reaching home, he feels pain in the abdomen and suffers from vomiting and loose-motion. As his body becomes cool and feeble, his father takes him to the doctor. Observing him well, the doctor gives him necessary treatment.

5. What is the nature of Rahimur's disease?
 - a. Diarrhoea
 - b. Food poisoning
 - c. Jaundice
 - d. Dysentery
6. What type of instructions may the doctor give as a result of the above disease?
 - a. Taking nutritious food
 - b. Avoiding open-food from outside
 - c. Taking care of physical exercise
 - d. Washing hands before eating

Read the following stem and answer questions 7 & 8.

Four years old Mina takes food at her own choice. She loves to take vegetables only. Sometimes water comes in her body and the body swells up. She goes to the doctor and the doctor gives the necessary suggestion. The doctor also advises her to change the food habit.

7. What is Mina suffering from?

- | | |
|-------------|----------------|
| a. Rickets | b. Anaemia |
| c. Marasmus | d. Kwashiorkor |

8. What type of food does Mina need to prevent this disease?

- | | |
|-------------------------|----------------------------------|
| a. Fish, meat and milk | b. Rice, wheat and potato |
| c. Butter, ghee and fat | d. Fruits, pulse and coarse rice |

Creative Questions

1. Both Jarif and Ahnaf are 7 years old. Their height is 3ft and 4ft respectively. Recently water comes in Jarif's body and the body swells up. So, he becomes sick. Though he looks healthy, he is physically very weak. On the other hand, Ahnaf goes to school regularly. But reading and seeing become a problem for him at night. As a result, he lags behind in study compared to others.

- How many elements of food are there?
- How does poison occur in food? Explain.
- Which disease has attacked Jarif? Explain.
- State the nature of the disease ahnaf has been suffering from. Give him some necessary suggestions to solve his problem.

2.

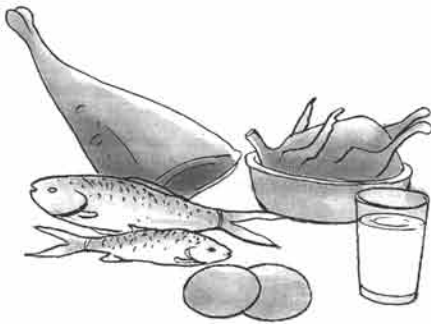

A



B

- What type of disease a person gets because of deficiency of vitamin 'D'?
- What may happen because of wrong policy of keeping and serving food?
- Describe the elements of food in picture A.
- Are the elements of the picture of B as described above essential for saving life? - Give reasons in favour of the answer.

Chapter Six

Drug Addiction and AIDS

Drug addiction has a mental and physical effect on human beings. It is created through mutual actions between living beings and the drugs he/she takes. A substance that brings about remarkable negative changes in physical and mental state is called a drug. The drug gradually increases its users' dependence on it. It also increases their eagerness for taking it more and more. Such a condition of a person is called drug addiction or intoxication. Thus, intoxication refers to addiction to drug substances. Cigarettes, tobacco, cigar, alcohol, marijuana, opium, heroin, morphine, phensedyl, yaba etc are addictive drugs. This addiction is dangerous. If anybody gets addicted to it they do not get relief from it easily. Our body has its own disease prevention capacity or immunity system. For this immunity system, any germs entering our body cannot harm it easily. But there are some harmful viruses that can destroy the whole immunity system of our body. HIV (Human Immunodeficiency Virus) is such a virus. HIV can be transmitted through blood, semen, breast milk etc. Once this virus enters a human body, people fall sick and they are not cured by traditional treatment. The contaminated status of HIV is known as AIDS (Acquired Immune Deficiency Syndrome).

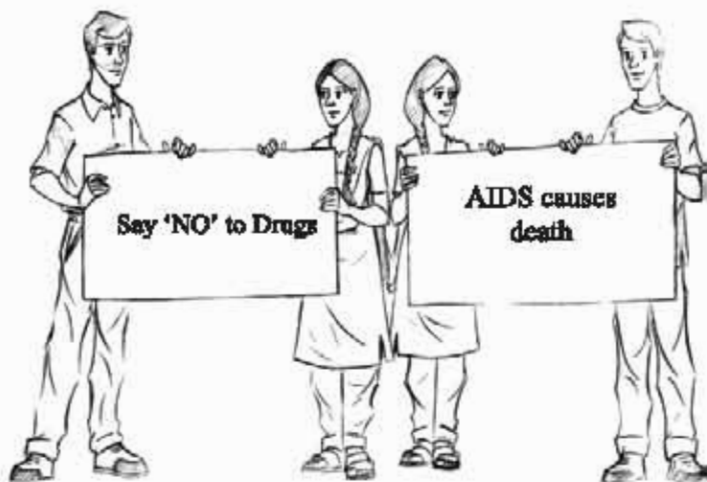

At the end of this chapter we will be able to—

- describe the causes and symptoms of drug addiction;
- explain the bad effects of taking tobacco and drugs.

- describe the techniques of that keep away from smoking and drugs;
- explain the role of others to keep individuals, family and society free from drug addiction;
- avoid smoking and drug carefully by realising their bad effects;
- explain the concept of HIV-AIDS;
- explain the out break and situation of HIV-AIDS in Bangladesh;
- explain the ways and means to prevent the spread of HIV-AIDS;
- describe the ways of keeping themselves free from the risk of HIV-AIDS;
- know about the nature of services provided by different service organisations working prevent HIV-AIDS;
- raise public awareness to keep individuals, family and society free from drug addiction;
- be motivated to lead a disciplined and sophisticated life by realizing the fatal consequences of HIV-AIDS.

Lesson-1: Drug Addiction, Tobacco and Intoxicating Substances and their Bad Effects

Drug addiction means strong attraction or addiction to any drug or intoxicating substances. The substances whose intake creates intense addiction are generally called drugs. There are some medicine items that are also considered as drugs for their use. Without prescription by a doctor if someone takes a medicine again and again, and if that medicine causes addiction, the medicine will be categorised as a drug. Therefore, the substances that cause harmful effects on human body and mind, and the users of those items feel strong attraction for or addiction to them, are called drugs. For example, cigarette, cigar, wine, marijuana, cannabis, heroin, opium, pethidine, phensedyl, sleeping pill etc are commonly known as drugs. People, who take drugs, gradually develop unusual dependence upon them. They cannot restrain themselves from taking drugs. In any case, if they cannot take drugs, there appear serious physical symptoms in them. Such as they become irritable; they may experience lack of appetite, low blood pressure and problem in breathing; they may also suffer from insomnia and develop aggressive attitudes.

Difference between medicine and drug

1. The use of medicines cures people from diseases but the use of drugs causes various diseases in human body.

2. There is a defined dose for a medicine but there is no dose specified for a drug.
3. One need not take medicine when disease is cured but a drug addict cannot give up drugs easily.

Common drug items known in Bangladesh are heroin, opium, pethidine, phensedyl, marijuana, cannabis, yaba, sleeping pills, alcohol and tobacco-made items. From tobacco leaves tobacco-made items are prepared. In tobacco leaves there is nicotine which is a drug. Drug items like biri, cigarette, chewing tobacco, snuff-tobacco etc are made from tobacco leaves.

Methods of taking drugs: Drug users take drugs in different ways and methods. For example, some drugs are taken into body through injection while some others are taken as a tablet, powder or syrup. Similarly some drugs are taken by drinking them as liquid though some others are taken by smoking. There are different methods of smoking as well. For example, cigarette, biri, cigar, hookah etc.

Bad effects of drugs and tobacco: There are many bad effects of taking drugs and tobacco. Taking tobacco mainly refers to smoking. Smoking is injurious for health. According to a report of World Health Organisation (WHO), in every 8 seconds one person dies from tobacco-related complications. The smokers and the people who inhale tobacco smoke passively suffer from many types of diseases. The bad effects of taking drugs are as follows:

1. Drugs affect mental health. For example, drugs reduce capability to learn and work, hamper power to manage stress and take decision and aggravate mental anxiety.
2. Drugs cast painful impacts on family and social life. A drug addict behaves with family members rudely and destroys family peace.
3. Drugs have very harmful effects on physical fitness as well. Drugs cause damage to brain cells, lack of appetite, and reduction of eye sight.
4. Some drugs increase the probability of HIV-AIDS and Hepatitis-B contamination. Drugs cause oesophagus and lung cancer, kidney diseases, high blood pressure and many other diseases.
5. Drugs incur financial loss. The drug addict creates unhappiness and causes want in the family in order to manage money for buying drugs.

Activity-1: Drug addicted people develop high dependency on drugs. Mention the consequences of such dependency.

- 1.
- 2.
- 3.
- 4.

Activity-2: Write down four bad effects of drugs.

- 1.
- 2.
- 3.
- 4.

Lesson-2: Ways of Keeping away from Smoking and Drugs and the Role of others in this Respect

The previous lesson has elaborately discussed the bad effects of smoking and taking drugs. But merely knowing about the subject is not enough to live a healthy and happy life. We should draw up a practical action plan immediately so that we can give up such harmful habits. The first and foremost thing is firm conviction of not smoking or taking any other drugs in any situation in future. At puberty the adolescents naturally feel very curious about the unknown and the forbidden. As a consequence of such curiosity and excitement or being influenced by friends or others, the pubescent may take up smoking or use drugs. Such curiosity or excitement may prove to be a cause of regret and remorse for the rest of life. Before quenching these excitements, the pubescent should think what problems smoking and alcohol may cause. If they consider the bad effects of alcohol and smoking, it is natural that they will not develop this bad habit. The following activities are to be followed if we like keep away from smoking and drug abuse.

1. We should bear in mind the bad effects of smoking and drug abuse cause to our health.
2. We should also remember that for smoking and drug addiction our parents, brothers and sisters, or guardians will feel embarrassed and ashamed. Teachers will never take it easily.

3. Then we should take a firm decision about this. If we can do that from the very beginning, we will be able to keep away from such disastrous habits.
4. At the time of taking a decision we should first analyse situations, identify problems and probable risks, and then collect required information on this subject. We have to gather information through various channels such as personal source, family source or social source. Finally, based on the information we should find out possible solutions to the problems and take necessary initiatives to implement.
5. Refraining from smoking and drugs is not enough. We should raise awareness and motivate our friends, classmates, relatives and acquaintances to keep far away from these fatal addictions.
6. We should work actively to create public awareness about harmful effects of drugs. Being aware of the evils of drug addiction, we all should keep ourselves, our friends, classmates and acquaintances away from smoking and drugs.

Role of others in keeping away from drug addiction: In getting addicted to drugs, bad influence of already addicted friends plays a crucial role. But all friends are not drug addicted and therefore, all friends are not harmful. Only a few friends get drug addicted whereas most of the friends are free from drug abuse and they are good. These good friends can motivate and influence others not to take drug. Apart from friends and peers, there are many others who also play significant role in keeping us drug-free. For example, the careful eye of guardians upon their children acts as the most effective measure in this connection. Also the role of teachers at school is very important. Teachers are role models to students. Students obey the advice and instructions of teachers with highest sincerity and care. Following the advice and orders given by the teachers in classroom or outside, students can avoid drugs. Similarly, relatives and neighbours by means of their love and affection can also help children keep aloof from the clutches of drug addiction. Furthermore, different mass media such as newspapers, radio and television through their anti-drug campaign and publicity can create wide public awareness too. On the other hand, taking legal steps and leading social movements against drug abuse, we can build a society free from drug addiction.

offers but also try to motivate them to come out of the evils referring to harmful effects of drugs. If the people offering for taking drugs create any pressure, we should inform our parents or guardians at home and teachers at school without delay. We should never take drugs even out of curiosity, otherwise disaster will ensue. We should realise that undoubtedly any type of drug is bad for an individual, family and society at large. Above all, we should have determination not to take drugs.

Activity-1: What are the bad effects of drugs on individuals and family?

Activity-2: An individual by taking drugs experiences physical, mental, social and financial harms. Mention one of these problems and discuss in brief what will be the possible solutions.

Lesson-4: Building Public Opinion against Drug Addiction

Drug addiction is one of the biggest social challenges nowadays. Like other countries, the number of addicted people is alarmingly increasing in Bangladesh. Though drug addicted people do not die immediately, they invariably encounter various types of physical, mental, social, and economic problems. The drug addicted people not only harm themselves by taking drugs, they also affect others such as their parents, brothers and sisters, children, relatives, friends etc. The drug addicted people get involved in many antisocial and illegal activities including theft, robbery, murder, banditry etc which are very harmful for individuals, family, society and the nation at large. We should try our best to create awareness and raise voice against drug addiction in order to save our young generation and society from the terrific consequences of drugs. Enforcement of existing laws should be ensured so that drugs are not easily available in society. We should build public opinion to make everybody aware of the dangerous effects of drugs.

Other than slogans in mass media, the following ways can be used to build public opinion against drugs-

1. To highlight the bad effects of drug addiction through radio, television, newspapers etc.
2. To broadcast information about drug abuse and dangers relating to it.
3. To hold anti-drug events like meetings, conferences, street dramas, singing songs, reciting poems, stage dramas, opera-shows, rally etc.

4. To highlight religious doctrines against drug addiction in mosques, temples and churches, discuss its harmful aspects and motivate all to keep away from drugs.
5. To observe anti-drug and anti-tobacco days in schools and organise various other programmes like group discussion, debate competition, leaflet distribution, poster display etc.
6. To declare educational institutions, different offices, organisations, departments as tobacco-free and drug-free zones.
7. To make everyone aware of the evils of drugs by printing anti-drug slogans on book covers and notebook covers.

At the time of building public awareness we should run anti-drug campaigns with the slogan “DRUG gives nothing but takes away everything”. Drug addicted people believe that drugs help people forget pains and give pleasure, which is quite wrong. Certainly, drugs beget more pains. If we find any of our acquaintances addicted to drugs, we all should try sincerely to help them return from the dangerous path of drugs.

Activity-1: Write such a slogan by which people can be motivated and made aware of the bad effects of drug addiction.

Activity-2: Write down what you will do to run an anti-tobacco campaign in your locality?

- 1.
- 2.
- 3.
- 4.
- 5.

Lesson-5: HIV-AIDS-Concept and out Break

There are a few fatal diseases by which people are getting attacked more and more. HIV-AIDS is one of them. Though there are medicines and treatments for many serious diseases, unfortunately the world is still waiting for any treatment that can fully cure AIDS. So, the consequences of AIDS are definite death. We have immune system in our body to fight against germs. Due to this immune system, any germs entering our body cannot harm easily. But there are

certain viruses that can gradually weaken our immune system and ultimately destroy it completely. Such a virus is known as HIV.

What is HIV-AIDS? HIV and AIDS are two abbreviations. Full forms of these words are Human Immunodeficiency Virus (HIV) and Acquired Immune Deficiency Syndrome (AIDS). HIV is a special type of virus that can enter a human body in a number of ways. HIV damages white blood cells and thus destroys immune system of the body. When the virus enters a human body, the patient frequently suffers from various other diseases such as diarrhoea, tuberculosis, pneumonia etc and no treatment and medicine work to cure them. Such a health condition of an HIV-contaminated individual is called AIDS. If HIV enters any human body, its symptoms are not visible immediately. Generally it takes time from 6 months up to a few years to be exposed as AIDS symptoms starting from the day HIV enters the body. In some cases it takes 5-10 years or more to detect AIDS from the date of HIV contamination. This time is called latent period. During this period HIV can spread to other's body from the people who have already acquired HIV.

Symptoms of AIDS: AIDS does not have any specific symptom. But when an AIDS patient is attacked by other diseases, the symptoms of those diseases are visible in the patient. Even there are some common symptoms of AIDS. They are- (1) Cough prolonging more than a month at a stretch, (2) Skin disease all over the body. (3) A kind of ulcer in face and throat, (4) Swelling of lymph glands, (5) Decrease of memory and intelligence etc.

Main symptoms of AIDS

- 1) Quick loss of body weight
- 2) Loose motion for more than a month
- 3) Frequent fever or over sweating at night
- 4) Excessive tiredness or fatigue
- 5) Dry cough etc.

We should remember that if any or more symptoms from the above list are visible in any individual, we cannot call them an AIDS patient for sure. HIV can be detected from blood reports under the supervision of an experienced doctor.

Spread of HIV-AIDS: HIV is a silent killer. In order to take cautionary measures against this fatal disease we need to know how HIV and AIDS are communicated from one person to another. HIV is not transmitted through air, water, food or general physical contact etc. Basically HIV lives in various body fluids such as blood, semen, vaginal serum, breast milk etc. When blood or

semen or vaginal serum of an AIDS patient enters the body of another person or when a child sucks breast of mother, they are contaminated by HIV virus. Basically HIV spreads in the following ways-

1) Illicit and unsafe sexual intercourse. The most common cause of spreading HIV-AIDS is unsafe sexual relationship. According to statistics, it is found that 80% of HIV-AIDS affected people have acquired this virus as a result of unsafe sexual union. HIV-AIDS virus enters the body of sexual partners via semen or vaginal serum of the affected people.

2) Taking blood of affected people: HIV-AIDS can be communicated through limb transplantation and needle and syringe already used by an AIDS patients. Drug-addicted people frequently use the same needles and syringe to take drug by many people together. Healthy people will be contaminated by using needles syringe used by an HIV-AIDS affected person.

3) From mother to children: The virus of HIV-AIDS can be transmitted from an affected mother's body to her children in three ways. They are-

- a) During antenatal period
- b) During delivery of children
- c) During giving breast milk to children

The activities for which HIV-AIDS does not spread are mentioned below-

- 1) Through sneeze, cough, spit or breathing
- 2) Living in the same house or eating together from the same plate etc
- 3) Playing together and studying in the same class
- 4) Shaking hands, embracing or using clothes
- 5) Through mosquitoes or other, insects
- 6) Nursing the affected people and
- 7) Using the same bathrooms or toilets

We must know all these things are preventive measures in order to save ourselves and our society from a deadly disease like HIV-AIDS.

Activity-1: Write down the symptoms of HIV-AIDS on the board and make a presentation in the classroom.

Activity-2: Read the following statements about how HIV-AIDS spreads and write 'T' for true and 'F' for false statements.

Statements	T/F	Statements	T/F
1. To nurse affected people		6. To suck breast milk of affected mothers	
2. To eat from the same plate with affected people		7. To use clothes of affected people	
3. To receive blood of affected people		8. To use needles and syringes used by affected people	
4. To transmit safe blood into the body of a healthy person		9. Through sneeze and cough of affected people	
5. To get bitten by mosquitoes and insects		10. To have physical relationship with affected people	

Lesson-6: Risks of HIV-AIDS in Bangladesh and Ways to Remain Free from Risks

AIDS is a socio-economic and public health problem. Bangladesh is also experiencing the outbreak of AIDS. Fortunately, it has not spread widely among common people of the society. It is a matter of great concern that HIV-AIDS may take serious form in course of time. Since there is no cure for this disease we all should be very cautious about it especially the teenage girls should be more careful about the fatality of such a disease. Actually, in Bangladesh girls are more vulnerable to AIDS than boys. The causes of girls' vulnerability are as follows-

1. Weak position of girls in socio-economic structure in Bangladesh
2. Girls being less aware of AIDS than boys
3. Violence against women due to gender discrimination in the society
4. Girls inability to prevent males from establishing unsafe sexual relationship.
5. Distinct physiological traits of girls.
6. Curiosity for sex and unsafe physical union etc.

One-fourth of the total population of Bangladesh are boys and girls of 11-19 years. Due to physical and mental changes at puberty, boys and girls have high curiosity in their thinking and activities. But in our culture, they do not share senior members of the family anything about this. As a result, they become

very emotional and in order to satisfy their curiosity they feel interested to establish physical relationship. In such a situation, they run the risks of HIV-AIDS contamination.

Risky behaviors for HIV contamination: In human body viruses live in semen, vaginal serum, blood and breast milk. HIV-AIDS contamination takes place through exchange of these four types of body fluids. That means when blood or semen or vaginal serum or breast milk enters one's body from the affected people, HIV-AIDS contamination occurs. The risky behaviors of HIV-AIDS contamination include-

- a) Taking drugs or using the same injection needles and syringes by more than one person.
- b) Injecting blood into body without checking.
- c) Using unsterilised equipment in surgical operations.
- d) Giving birth to children by HIV-AIDS affected mothers
- e) Establishing unsafe physical relationship etc.

Ways to keep free from HIV and AIDS risks

1. Avoid risky behaviors : We should avoid risky behaviors .
2. Control emotion: Adolescents mainly get engaged in risky behaviors as a result of curiosity and emotion. We should control curiosity and emotion to avoid risks of HIV-AIDS.
3. Reject risky proposal: We should be tactful and skilled in saying 'no' to any unwanted and immoral proposals.
4. Follow religions and social customs: No religion or society supports drug addiction, illicit physical or sexual relationship and other immoral activities. Therefore, following religious regulations one can keep away from risks of HIV, AIDS contamination. Being religious helps to reduce HIV-AIDS risks.
5. Building awareness about HIV-AIDS: We should take necessary steps to ensure wide public awareness about HIV-AIDS. In this regard we should make publicity through mass media, organise rallies and make use of electronic media as well. People should be motivated through traditional folksongs, '*palagaan*' by rural bards, street dramas and cultural programmes to be aware of the dangers of HIV-AIDS. All these programmes will play a very significant role in raising self awareness of individuals and ultimately public awareness in society.

Activity-1: Students will divide themselves into groups and make a list of risky behaviours of HIV-AIDS contamination. Each group will discuss on a risky behaviour in the classroom.

Activity-2: What is the most effective strategy for raising awareness of HIV-AIDS? Show your argument in favour of your answer and make a group presentation in the classroom.

Lesson-7: Risk of HIV-AIDS in Bangladesh

Sexually Transmitted Diseases (STD) and AIDS are two much talked issues of the present world. AIDS was first detected in America 1981. AIDS is such a dangerous disease that it decreases human life and hampers economic growth of a country. AIDS is seen as one of the barriers to human civilisation and development. The number of affected people is increasing day by day. According to UNAIDS reports, 50% of people who are getting affected by AIDS every year belong to the age group below 25 years. Various socio-economic factors such as lack of opportunities for education and health service, and economic incapacity compel the young generation of poor countries to take risks of HIV-AIDS contamination. In Bangladesh, there are cases of HIV-AIDS outbreak but it has not spread among mass people yet. Even then due to world situation and regional circumstances, we cannot remain inactive. It has been observed that HIV-AIDS is spreading widely in many countries such as China, Cambodia, Vietnam and Nepal and Myanmar, two neighbouring countries of Bangladesh. So, we have to take appropriate steps before Bangladesh becomes more risky in this regard. In Bangladesh, the rate of HIV contamination among high-risk-people such as drug users, male and female sex workers, homosexuals, professional blood sellers, floating people etc. is quite high. The HIV-AIDS contamination among the drug users has taken an epidemic form due to taking drugs by many people using the same needles and syringes. Though the current rate of HIV contamination in Bangladesh is below 1% there is no guarantee that the scenario will remain the same in future. AIDS does not break out as epidemic at the beginning. That HIV explosion will not take place in Bangladesh cannot

be said for sure. There is no effective cure for AIDS as yet, so its prevention is recommended all over the world. The countries of the world observe the 1st of December every year as 'World AIDS Day'. On this special day all the countries from their respective position take various programmes to prevent AIDS.

Activity-1: Students will divide themselves into a few groups and make a list of risky behaviors that may lead Bangladesh to take an epidemic form of HIV contamination and make a presentation in the classroom.

Activity-2: Prepare an activity plan in order to observe World AIDS Day and make a presentation.

Lesson-8 : Role of Service-Providing against HIV-AIDS

AIDS is an incurable disease in the present-day world and its consequence is definite death. There are cases of AIDS in Bangladesh and the number of affected people is increasing gradually. Since there is no cure for AIDS as yet, prevention is the only way to control it. Therefore we have to put emphasis on preventive measures. In 1985 the Government of Bangladesh formed a committee called National AIDS Committee to control the outbreak of AIDS. In 1988, Bangladesh drew up short-term programmes to control AIDS under financial support by World Health Organisation (WHO). But the Government has been undertaking various programmes and steps to fight AIDS in Bangladesh. These programmes are being implemented by the Government and Non-Government organisations. Side by side with Government organisations, the Non-Government service providers are also playing significant roles in this regard. In every Government medical college and hospital, services like blood-screening, counseling and limited treatment are available for HIV-AIDS patients. Among NGOs Ashar Alo Society, Jagorani Medical Clinic, Mukto Akash Bangladesh, HASAB (HIV-AIDS and STD Alliance in Bangladesh), CAAP (Confidential Approach to AIDS Prevention) etc and HIV-AIDS-related service providers have set up extensive programmes as well. Service-related programmes mainly include (1) counseling and (2) rehabilitation.

Counseling : As yet there is no vaccine or medicine for HIV-AIDS. But psychological support and strength, proper medication and nursing can help HIV-AIDS-affected people live long healthily. Therefore mental support and counseling services are very crucial for them. At the initial stage, non-Government service provides collect required information about HIV-AIDS victims, then they hold yard-meetings near the houses of the victims. In the yard-meeting, experienced doctors and experts are invited for open discussion on what HIV and AIDS are, how HIV spreads, how to deal with the victims etc. Different NGOs taking expert counselors with them regularly to visit the HIV-AIDS patients at their houses. They provide various treatments to the patients along with required services.

Techniques of counseling: HIV-AIDS can be detected by examining blood of a patient. Counseling is necessary before and after blood examination. Counseling is very important because any person found with HIV positive gets seriously afraid. They think about the fatal end of AIDS when there is no cure for it. But the AIDS victims can live long provided they get required care, proper food, mental support etc. by others. We should follow the following steps in counseling patients.

1. Counseling after blood test: Anybody detected with HIV positive in their blood gets mentally very weak. So, counseling after blood test report is very vital. Only through advice and counseling the victims can be brought back to normal life. The victims should take care about regular intake of nutritious food, sufficient rest and sleep. Their mental strength can be enhanced through giving them doctor's advice regularly.

2. Beware of other diseases: HIV positive patients gradually lose their immunity. As a result, various diseases like diarrhoea, tuberculosis, high fever etc. take the opportunity of the patient's vulnerability. In such cases, patients should take medicine and treatment as per the experienced doctor's advice.

3. Treatment as per doctor's advice: There is no treatment for AIDS till today. Medicines of antiretroviral group can be used to make the patients remain quiet well and thus live long. But these medicines are extremely expensive.

Rehabilitation: There are many Non-Government organisations that provide different types of vocational training to the AIDS victims in order to make them self-dependent. Furthermore, in special cases, there are services like financial donation for their rehabilitation.

Activity-1: Suppose you are an officer of an NGO, working for HIV and AIDS victims. Write how will you provide counseling services to them?

Activity-2 : Make a list of issues you will highlight at the time of counseling the family members of an HIV victim.

Exercise

Multiple Choice Questions

1. What is made from Tobacco leaves?

a. Opium	b. Marijuana
c. Cigar	d. Cannabis
2. Because of taking drugs
 - i. abnormal behavior is observed.
 - ii. unrest occurs in family.
 - iii. appetite for food gets reduced.

Which one is correct?

- | | |
|-------------|----------------|
| a. i & ii | b. i & iii |
| c. ii & iii | d. i, ii & iii |
3. Which system is the best against drugs addiction?

a. Controlling	b. Penal
c. Cooperative	d. Preventive

Read the stem below and answer questions 4 & 5.

As Shamim was wounded at the collapse of Rana Plaza, the authority took him to the hospital quickly. Seeing his excessive bleeding, the doctor suggested to donate him blood as fast as possible . To save Shamim, a man present there donated a bag of blood. After receiving the blood and some other treatments, Shamim got round and returned home two weeks later. After six months he started suffering from itching and dry cough. Besides, he also suffered from as possible continuous fever and diarrhoea. When he went to the doctor, after some tests the doctor prescribed him some medicine and also told his family to behave sympathetically with him.

4. By which disease was Shamim affected?

a. Diabetes	b. Asthma
c. AIDS	d. Typhoid

5. The need for Shamim's normal life is
- i. mental peace
 - ii. appropriate nursing
 - iii. staying away from family.

Which one of the following is correct?

- | | |
|-------------|----------------|
| a. i & ii | b. i & iii |
| c. ii & iii | d. i, ii & iii |

Creative Question

1. Shajal is a good student of class ten. For a few days, he has not been attending school regularly. He is often seen to be loitering with bad street boys. His class teacher informed his father about the matter. Shajal's father himself observed the matter and said that recently he had been returning home late at night. If anything was asked, he became angry. He became aggressive. Shajal's father asked for the help of his teachers, neighbours and friends to cure Shajal. His friends started taking him to different cultural programmes. Sometimes he participated in games and sports and went to visit beautiful places. After a few days, Shajal became well.
- a. What is a drug?
 - b. Explain why the ability of learning and working is reduced.
 - c. What type of problem did Shajal face? Explain.
 - d. Whose role do you think is the most important for Shajal's getting well? Analyse according to the stem.

Chapter Seven

Puberty & Reproductive Health

After birth, a baby gradually grows up. We call the stages of growth as Stage or Phase. A baby up to the age of five is called to be in its infancy or babyhood. A boy or a girl during their infancy is called a baby. The age between 6 to 10 years is called childhood. If a child is male, he is called a boy and if it is female, she is called a girl. A boy or girl from 10 to 19 years is called a teenager or adolescent. This very time is called puberty.

During this phase, their body starts the process of emerging into the body of a girl or a boy with the distinction of gender. Puberty is a stage or phase between childhood and youth. The knowledge on the specific organs of the body directly related to reproductive functionalities is called the issues of reproductive health. Be it a boy or girl, the reproductive health of a boy or girl is associated with the general health for the various phases of human being ranging from infancy to childhood, to adolescence and to a grownup person. So, everyone should know about reproductive health and the ways and means to preserve it as well.



A boy and a girl during puberty

At the end of this chapter we will be able to—

- explain puberty and the various changes taking place during this period/time;
- identify the do's and don'ts of the physical and mental changes during puberty;
- explain the strategy of how to face the various mental pressures and frustrations during this period;
- describe the necessity of nutritious food at puberty;
- explain the reproductive health and the possible measures for the sound maintenance of the same;

- explain the rules of reproductive health;
- explain various health tips and services during pregnancy;
- have ideas about autism and describe it.

Lesson-1: Puberty and the Related Changes during Puberty

A human being undergoes various stages/phases with the advancement of age. These are sequentially infancy, childhood, adolescence, youth, middle age and old age. The age of a baby from 0 to 5 years is called infancy. Again, age between 6 and 10 is childhood, while the age between 10 and 19 is adolescence. A boy or girl during adolescence is called adolescent. The process of changing into male or female starts during adolescence. This very nature and functionality of adolescence is called puberty. The puberty of a girl starts earlier than a boy. The puberty stage begins during the age range of 8-13 years in case of girls. On the other hand, the puberty stage of boys usually starts during the age range of 10-15 years. But in some cases, puberty may start earlier than the stages mentioned here for some boys and girls.

The Changes during Puberty: The physical or physiological changes are prominent during the evolution stage of puberty. On observing these changes, it can be perceived that someone is passing or undergoing the puberty stage. The changes that usually take place during puberty are of three kinds such as 1. Physical or physiological, 2. Mental or psychological, 3. Behavioral.

The physical or physiological changes during Puberty

The changes that are prominent in case of adolescent boys are

1. Weight and height increase.
2. The body tones and tightens and the shoulder and chest widen.
3. Moustache and beard sprout.
4. Vocal cord becomes strong, harsh and crude/coarse.
5. Nocturnal emission and ejaculation take place.

The changes that are prominent in case of adolescent girls are

1. Weight and height increase.
2. The bone becomes harder, wider and fatter.
3. Menstruation or period starts.

Various adolescent boys and girls may not experience the same kind of changes or growth during their puberty. As for example, some adolescent girls start

menstruation earlier or later than the benchmark set against the age range. In case of a boy or a girl adolescent, the height of everyone might not always increase equally .

The Mental or Psychological changes during Puberty: During puberty, certain mental or psychological changes also take place side by side with the physical or physiological changes. These changes are natural and the adolescents try to accommodate these changes with the passage of time. The mental or psychological changes that happen during puberty are-

- a. One becomes inquisitive about things unknown and unfamiliar.
- b. Confusion, hesitation and shyness become pervasive in movement and daily activities during physical changes.
- c. One feels the urge to be independent or egalitarian.
- d. The urge for attention and love of the dear and near ones becomes intense.
- e. The tendency to be moved by emotion becomes dominant and strong.
- f. The girls and boys feel attraction towards each other.
- g. The stage of mental maturity starts.

Behavioral Changes during puberty: The behavioral changes that we notice among the adolescents are-

- a) To act like the grown ups.
- b) To prove or establish him or herself as a distinct individual through various regular and natural activities.
- c) To form one’s own opinion and idea in every matter.
- d) To increase interest on brave and risky work.

Activity-1: Form a group of 5/7 students according to the instruction of the teacher. Think about your classmates or year mates. Fill in the table below with the things that have commonly happen to all. Give the title, “General Changes”. Then make another list of those changes that are uncommon and give its title, “Other Changes.” This will be a group activity.

General changes during Puberty

Physical or Physiological Changes	Mental or Psychological Changes
1.	1.
2.	2.
3.	3.
4.	4.
5.	5.

Other changes during Puberty

- 1.
- 2.
- 3.
- 4.
- 5.

Lesson-2: To Adapt with the Mental or Psychological Changes during Puberty

Generally the time or period of the boys and girls during the age range of 10 -19 is called puberty. During puberty, the boys and girls develop numerous changes in their physical structure and physiological aspects while mental or psychological changes also prominently increase. But due to a variation in climate, geographical location, topographical elements, food intake and mental makeup, one might differ in starting the time of puberty with the other. The ingredient or element solely responsible for various changes during puberty is actually a kind of chemical substance/matter called 'Hormone'. Estrogen and Progesterone are two hormones responsible for various mental or psychological and physical or physiological changes among girls. Physiological and psychological changes that happen to boys are due to the emergence of a hormone called Testosterone.

The mental agony or pressure during puberty: Due to physical and physiological changes among the boys and girls, mental agony or pressure takes place at the same pace, because these changes happen with a sudden intensity. Not being familiar with these changes, one becomes frustrated or worried sometimes. If a girl or boy is well briefed about the do's and don'ts during this stage, He or she will not be worried or lost or at a fix. They will not have even the sense of guilt in them. These sort of guilty feelings and mental agony are injurious to health. Some sort of discomfort and instability works among the boys and girls during puberty. They face severe mental torments and often cannot concentrate on their studies and regular chore of life.

To adjust with the psychological changes during puberty: If the adolescents are aware of the changes during puberty and have preconceived ideas and knowledge on the same, they would have the mental preparation for such happenings. Consequently, they can take things easily and their regular activities may also remain unhampered. At the same time, they can also prevent some possible diseases associated with these. While changes take place at puberty, one can discuss the issue with his or her parents, elder brothers and sisters or anyone reasonable, responsible and guardian-like and form ideas and get rid of unnecessary ill-feelings and a sense of guilt. As a result, confusion and frustration will overcome and a tendency towards leading a solitary lifestyle would also be minimised. During puberty, the boys and girls also develop some sort of emotional changes. At this stage, to help the adolescents adapt with the mental or psychological changes, the parents and guardians have to be very sympathetic and friendly with them. They need to be encouraged and supported in terms of their mental or psychological changes including all other changes. The adolescents themselves have to be careful and attentive as well to ensure their sound mental health. Their first and foremost task is to adjust with the physical or physiological and mental or psychological changes happening inside them. Reading good story books and playing with inmates, classmates and year-mates can naturally keep them jolly and jovial and help them reduce such mental pressure or agony.

Activity-1: Teacher will ask the students to write down in groups some ways to overcome the mental stress in the adolescent period.

Lesson-3: The Necessity of Nutrition during Puberty

During puberty, boys and girls need nutritious food because, they grow abruptly and the activities of the body also increase rapidly. This is why they need to take nutritious food. But many boys and girls and even their guardians do not pay much heed to this matter. Some hold the opinion that nutrition and rich food values are only found in expensive food and fruits. But such ideas are grossly mistaken and misleading as well.

If one is cautious and selective, one can derive rich food value and nutrition from easily available and less expensive food and fruits.

The necessity of nutrition according to age, physical structure and nature of job

A balanced diet is one that includes all the six essential elements of food value and nutrients. According to age-diversity, the amount of balanced diet for an individual may vary. As for example, an adolescent of 13/14 years old requires more nutritional package than a child of 8/9 years old. There is no variation in the nutritional intake between a baby boy and a baby girl; between an adolescent boy and adolescent girl or male youth and female youth. Again, if among two youths of the same age, where one is quite tall and healthy and the other is undersized and of ordinary health, the food intake would drastically vary and the one who is well-built and hardworking would consume more food due to his or her health and body structure while the other one's intake will be reasonably lower. This disparity in food intake may even happen between two girls or females of the same age and body structure. This is how the food intake varies depending on the variation in age, body structure and job nature. All the six elements of food are essential for each individual during the puberty period or stage both for the physical and mental growth. These foods provide essential nutrients to the body necessary for balanced and proportionate growth. Besides, malnutrition among the adolescents may cause various diseases.

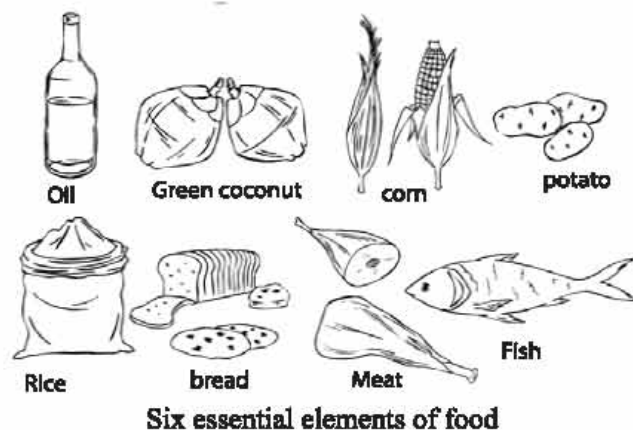

Six essential elements of food

Activity-1: Prepare a list of balanced diet for the adolescents. This list should include all other items that are cheap and easily available.

Activity-2: Write about the disadvantages if boys and girls do not take nutritious food and also about the necessity of food and its variation according to age, body structure and job nature and discuss those in class.

Lesson-4: Reproductive Health and Protection of the same

The reproductive organ and the process associated to reproduction, are called reproductive health. So, reproduction in its original sense means to give birth to babies. The safe and healthy birth of future generation actually depends on the healthy lifestyle and reproductive organs of the present generation. So, for a healthy, safe and joyful lifestyle and livelihood, everyone should acquire proper knowledge about reproductive health.

The necessity of reproductive health and ways and means: At puberty by the hormonal changes, the girls and boys undergo certain physical and physiological changes. If the boys and girls do not have any preconceived ideas about such changes, they usually get worried and harm themselves being misled by faulty ideas and conception. Cleanliness is the most vital part of reproductive health. When menstruation happens, it is essential to be neat and clean and take regular bath/shower. During this period, one needs to have nutritious food and enough water. A girl should take advice of the parents, health workers and close relatives about these issues. Keeping this period in mind, the parents and guardians should be friendly and sympathetic towards them. Supportive and friendly attitudes would help them to come out of such worries and discomfort and consequently would make them happy and facilitate their healthy growth. The biggest and worst risk of reproductive health is to get married at an earlier age and be pregnant. Besides being attacked by various diseases, there exist potential risks of death both for mother and the baby. To protect reproductive health, one must be married at adulthood. If one follows the government order, one can easily avoid such risks. Disease in reproductive organs may break out for various reasons. One should not hide if one is attacked by venereal or reproductive-organ-related diseases. One should take medicine and instructions from a competent doctor. This can help avoid infectious and venereal diseases.

Activity-1: Write in the table what to do in order to protect reproductive health.
--

Things to be done

- | |
|----|
| 1. |
| 2. |
| 3. |
| 4. |
| 5. |

Lesson-5: The Health Rules for Reproduction and the Service Required during Pregnancy

One of the special parts of the whole human health is reproductive health. Reproductive health does not necessarily mean the absence of diseases related with reproductive organs. Reproductive health means and includes safe and secure reproductive process through sound and safe physiological, psychological and behavioral condition. Delivery is the process of begetting a new human being. The healthy future generation largely depends on the holistic approach initiated for the reproductive health of the present generation.

Various indispensable elements incorporated with reproductive health:

1. The reproductive health rules during puberty: During puberty boys and girls need to abide by the rules and regulations of reproductive health.

2. Pregnancy at the proper time: A girl should not conceive before 20 years of age. If conceived at the proper age, it becomes beneficial both for the child and the mother.

3. Safe maternity: Safe maternity means and includes the maintenance of a healthy state and condition of the carrying mother right from the pregnancy, to delivery to post-delivery stage. The death rate of maternal morbidity is high in Bangladesh. The main reason of such maternal morbidity is that the mother during pregnancy is not properly taken care of.

She hardly gets adequate food, medicine and medical facilities. Besides, early marriage and pregnancy also cause the illness and malnutrition for both mother and baby.

4. Early care/pre-natal care for the baby: After being conceived, if the pregnant mother does not take nutritious food, receive proper medical treatment, take proper rest and sleep and keep clean and fresh, she is very likely to suffer from various complicated diseases.

5. The care of the nascent baby: A baby from its birth up to 28 days is called a nascent child. Right after its birth, it is crucial to lactate the baby, provide adequate food to the lactating mother and the baby as well as immunize the baby by the right vaccination.

6. The nutrition of the child and the mother: Most of the babies and mothers in our country suffer from malnutrition. Since the pregnant and carrying mother suffers from malnutrition, consequently, the baby is also affected by malnutrition. The main reason of such pregnancy is to be repeatedly pregnant and having children.

7. The treatment and clinical care of various diseases relating to reproductive organs and the prevention of such diseases: Among all such diseases, some diseases are worth mentioning. These are infectious diseases, venereal diseases, malignancy of the productive organs and HIV/AIDS. The affected persons should contact with the various consulting agencies responsible for the treatment of these diseases and take necessary consultancy from them.

Healthcare during pregnancy: Pregnancy is a special kind of change in human body. When a baby is conceived, this change in body only happens to the mother. Some irritable syndromes are noticed or felt by the females/going-to-be-mothers within a few months from the time of conception. The common syndromes are menopause, vomiting tendency or vomiting, giddiness, frequent urination. If someone is pregnant at an adult stage, she does not suffer from serious complications relating to physiology or psychology or behavior. The essential services and nursing cares to be rendered during pregnancy, according to standardized norms of reproductive healthcare literature, are-

- a. To be clean and fresh.
- b. To take bath or shower regularly.
- c. To take nutritious food, rest and sleep properly.
- d. To be under direct supervision of a competent gynecologist.
- e. To keep contact with the nearby clinic to combat pregnancy-related complications.
- f. To safeguard the reproductive organs from any sort of infection.
- g. To abide by the religious and social norms and etiquette. So, one should keep oneself busy or occupied with studying various books and various family or social activities.

Activity-1: Prepare a list for a pregnant mother for the various precautions mentioned in this book.

Activity-2: Write chronologically the various irritating syndromes that are observed among the pregnant mother within a few months from the time of conception.

Lesson-6: Autism

We pass our day to day life through various odds and problems. Happiness and sorrows are everyday phenomena of human life. When a baby is born in a family, everybody becomes happy and excited. Parents keep planning so many things for the bright future of the new-born. One of the issues of their planning is healthy and normal development of the child. Physical, psycho-social and intellectual development of a child takes place in a certain way but there are some exceptions in this respect. Parents get worried when they see that their child is behaving differently from other normal children or not following normal rules of development or lagging behind its age group. Gradually there prevails despair and frustration in the family. At first parents have to struggle with their own minds to accept the difference in their child. At the same time, parents have to face many odds due to negative attitudes of society and family members towards the baby. Normal development of a child includes acquiring physical skills (sitting, standing, walking, using hand etc), mental skills (intelligence, emotion, memory, thinking, behavior, personality) and social and communication skills with the growth of age. On the other hand, development related problems are usually a longstanding condition of a child, which happens at the time of brain development of a part or whole physical system. Autism is one of the development-related problems of children.

What is autism?

Autism is not a disease. It is an extended form of neural development-related problems which is known as autism spectrum disorder. Here 'neuron' means neural system which is related to brain. Again by development-related, we mean development process of children. The problem of autism is found in early childhood and it impedes normal development process of a child. Generally symptoms of autism are exposed from 18 months to 36 months after a child was born. Abnormality in social relationship, communication and behavior is the main area of this problem. Besides, autistic children also suffer from physical, intellectual, learning process and sensitivity-related problems. We should bear in mind that all autistic children are not the same. There are some symptoms

common to all autistic children but there are some other symptoms which vary from child to child. In autism spectrum, different types of autism are found. Autism spectrum can be compared to a rainbow. Like many colours in the rainbow spectrum, there are types of autism in autism spectrum. One of this type is known as Asperger's syndrome.

Asperger's syndrome: It is one kind of autism seen on the autism spectrum. Children suffering from this syndrome can naturally develop intellectual and linguistic skills though they have problems with behaviors. In spite of having normal language skills and adequate vocabulary, they find it difficult to participate in social conversations. They repeat similar behaviors again and again. Specifically they cannot understand minute details of communication such as making eye contact with others, facial expressions of others, signs and signals, body language and expression of emotions. They analyse words literally and consequently they fail to understand idioms, proverbs, fun or taunts. Such children do not suffer from retardation in development. In education they do better and even their intelligence is higher than that of common children. Asperger's syndrome is detected much late even at puberty or manhood. The rate of asperger's syndrome is ten times higher in boys than in girls.

Children with asperger's syndrome can read and write properly and confidently but they cannot understand the relevance of facts. Usually, students with asperger's syndrome have huge stock of vocabulary, they can speak systematically and often they can discuss on their favourite topics for long. But the problem is that they hardly realize whether the audience is interested in the subject.

It is difficult for them to maintain social communication through games and sports as they have problems in neural system, difficulties in physical movement, lack of attention to any subjects, lack in sense of time and problems in muscles. Students with this syndrome may suffer from anxiety because of their problems in organising power and concentration in work. They love to follow rules and regulations, instructions and routines in life. Any break of rule causes them mental uneasiness and confusion.

General behaviors of autistic children

- Not making eye contact
- Not responding to calls
- Inconsistency in skills-related development
- Opposing any change in daily routine

- Showing hyperactivity or excitement
- Problems in expressing emotions
- Abnormal physical gestures
- Not being afraid of real dangers whereas getting scared in normal cases
- Irrelevant laughter or cry
- Unnatural attraction to something
- Abnormality in eating, sleeping, discharging urine and stool
- Harmful behavior for self or others
- Eating anything

Main characteristics of autism

For each child the characteristics and degree of autism are different. Main identifying characteristics are social interaction, communication with others and repetitive behaviors. These three are known as main characteristics to identify autism. Due to autism the feeling of senses, skills of communicating with others and social interaction get retarded. As a result, repetitions of behaviors or enthusiasm for inconsistent behaviors are seen. We should know that autism is caused by neurotic problems and therefore symptoms of two autistic patients are not exactly the same.

A. Social symptoms: Most of the autistic children find it very difficult to maintain social interaction with others. In the first few months of their life, they do not maintain direct eye contact with others. They are indifferent in attitudes and like to be alone. They do not expect attention from others and also do not like to be hugged. They do not show normal reaction to others anger or affection. The autistic children take a long time to learn anything and they do not react to the thinking or feeling of others. Common gestures such as smiling, eye blinking, or facial expressions carry little meaning to them. The children who do not understand the meaning of gestures cannot understand the meaning of the sentence "Come here" in different situations. As they do not realise the meaning of body gestures and facial expressions the social world remains meaningless to the autistic children.

The tendency of the autistic children's being excited and aggressive blocks them from developing social relationships. When they go out and see unfamiliar people, they get angry or frustrated; some of them lose control upon themselves. At that time they may break things, hurt others or even their own body.

B. Problem of communication: Language is the main medium of communication. Due to language problems, autistic children face difficulties in communication with others. From linguistic development aspects, autistic children are different. There are some autistics children who never learn how to speak and thus remain speechless for the whole life. Some other children do babbling after a few months of birth but it also stops. Again for some others it takes 5-9 years to learn language. But the autistic children can learn to communicate with others by means of picture, signs, or touch. Many autistic children show abnormality in language use. They cannot make correct sentence by using correct words, some of them express their minds with a single word; some others repeat the word they hear. Some autistic children listen to a word and keep repeating the same like a parrot. It is called echo-lalia.

There are many other autistic children who have little problem in language use. They can use many words and have conversations correctly. But they cannot understand the differences in meaning of the same sentence in different situations. Again they also cannot properly realise the changes of meaning caused by changes in body movement and tone.

C. Repetative behaviors: Children with autism are physically normal and almost all of them have ability to control muscles but unusual repetitive behaviors make them different from other children. This repetitive behavior may be either mild or acute. Many of them move their hands again and again, stand up on the toes, or keep standing in a special style for long time. Often they do not play with toys like cars and trains but they arrange them in a line. If any one breaks the line of toys carelessly, they become worried and frustrated.

Children with autism want to see everything as it is around them. They do not like change of any sort. They get very annoyed if there is a little change in daily routine like timely eating, taking bath, following the same road to school etc. Repetative behaviors keep them engaged in such as gating at moving fans or lights for long time. Some of them take special interest in numbers, signs or science.

Some distinctive qualities and strong aspects of autism

Some autistic children show outstanding skills and abilities in some specific areas. The number of such gifted children is insignificant but such special qualities make them different from others. It is not true for every autistic child. The guardians should be careful about special skills of the autistic children and thus they will be able to help the children develop their preferred skills through proper care and attention.

It is found that autistic children can develop their talent in any area they pay attention to. For example, by paying attention to calendar such children can remember dates of births of many famous personalities and thus they can remember lots of information at a time. Again by paying attention to a difficult and technical task they can solve the problem by dividing it into small parts.

Some strong sides of autistic children

- Ability to observe minutely
- Understanding and remembering discipline and routine, sequence pattern etc.
- Memorising mathematics, time table of trains, scores in a game etc.
- Skills in computer and technology
- Interest for music and musical instruments
- Attention to special subjects of preference
- Artistic skills
- Reading written language at early age in spite of problems in understanding
- Memorising spellings of words
- Truthfulness
- Skills in solving problems

Causes of autism spectrum disorder

In short, it can be said that why autism occurs is not known yet. But along with increase in awareness and knowledge of autism, the search for its causes is also going on more widely. Though its actual cause is still unknown, it is scientifically established that autism may occur for many unidentified reasons. From the complexities that arise from autism it can be inferred that there might be a number of causes of autism. Any time during antenatal period, during birth or postnatal period autism may take place due to genetic influence or risky environment.

Only a few symptoms of autism in children do not prove that they are suffering from autism. Only can a specialist doctor say whether any child is suffering from autism or not. Doctors like child disease specialists, psychiatrists, child psychiatrists, child neurologists, psychologists or doctors trained in autism are the right persons to diagnose autism.

Inclusion of autistic children into mainstream education programmes

Education programmes for autistic children should be intense and elaborate. In that case specialist professionals are needed to determine how many hours a week autistic children will spend for study, based on their behaviors, development, social and academic needs etc. Only a single method may not be enough to educate autistic children and that is why more than one method may be tried at a time or gradually. Based on applied behavior analysis principles a number of methods may be applied to autistic children where necessary.

Side by side with normal education system, the teachers have to provide necessary care for education and development of the autistic children. To prepare guardians and others family members to take necessary steps to help the autistic children in their strengths and needs, there should be good communication among them regarding effective strategy, coordination and assistance for the development of the children. Not only classroom education for autistic children but also inclusion of them into mainstream education is important. It may be for short time but effective inclusion into mainstream increases the autistic children's confidence and skills. For the success of autistic students in their academic performance, others' positive attitude towards them is very essential. Therefore, their small successes should be highlighted to encourage them. If the teachers as well as parents and other family members know the characteristics of autism and qualities of a specific student, they can make a practical plan to develop the autistic.

How you can help your autistic friends at your class

Classmates of autistic children are called 'cooperative friends'. We should realise the concept of friendship and develop environment of being united so that autistic children can grow with proper help and due respect. Compassion and positive mentality for autistic children will benefit all of us because among them some are our brothers or sisters or neighbours or relatives. Autism-related education or training for compassion should not be based on specific students but it should be universally applicable to all.

Role of classmates for autistic children in understanding instructions and social interactions

1. Taking students from one class to another
2. Keeping classroom work and educational equipment tidy
3. Maintaining daily class routine
4. Encouraging interaction with other students

5. Retelling the gist of what the teachers teach in the class
6. Assisting the autistic children to participate in classroom discussions
7. Helping them express their answers made orally or with communication machines in writing
8. Giving them required guidelines and motivation when they are frustrated
9. Rewarding autistic children for maintaining communication with others
10. Giving necessary instructions to understand classroom activities

Generally the symptoms of autism may be there in a person throughout their life but proper care, assistance, guidelines and education may improve some of the symptoms to some extent. Those who have minor problems may improve remarkably and lead more or less a normal life. It is seen that children with acute problems do not improve much in speech and cannot take care of themselves even. Obviously, if the problems are detected in their early years, intensive training and instructions may help the autistic children achieve success in many fields.

A good number of voluntary organisations namely Proyash, Autism Welfare Foundation, SWAC, Autistic Children Welfare Foundation etc have been developed in Bangladesh to deal with the problems of autism. There are some specialised schools for education and training of autistic children. Government support and sponsorship will help these organisations develop more and contribute effectively.

Activity-1: Write down the symptoms of autism.

Activity-2: Write on the board what should the classmates do with autistic children?

Exercise

Multiple choice questions

1. What type of food is rice?
 - a. Protein
 - b. Sugar
 - c. Fats
 - d. Minerals
2. One of the main reasons for malnutrition of mother and child is -
 - a. Early marriage
 - b. Ignorance
 - c. Becoming mother in quick succession
 - d. Lack of treatment

3. What is reproduction?
- a. Feelings during pregnancy
 - b. Abortion
 - c. Taking care of the new born
 - d. Giving birth to a child
4. The reasons for changes at adolescent period are -
- i. Differences of nutrition
 - ii. Hormone
 - iii. Reproductive health

Which one of the following is correct?

- a. i & ii
 - b. ii & iii
 - c. i & iii
 - d. i, ii & iii
5. What type of changes happen in a teenager's body due to hormones?
- a. The body gets heavy.
 - b. Bones get thick.
 - c. Chest and shoulders get broad.
 - d. Height increases and weight decreases.

Read the stem below and answer questions 6 & 7.

Mr. Shafiq is a farmer. His daughter Nafiza is in class six. Due to his needs, he was facing trouble in continuing her study. In this situation, he got her daughter married. After a year, she became pregnant. After delivering the child, Nafiza became ill. Observing Nafiza's condition, their next door neighbour, a school teacher, made a huge campaign against early marriage. Many young boys of that locality took initiative to make the campaign successful. As a result, there was no early marriage in the last three years in that area.

6. What is the reason of Nafiza's condition?
- a. Pregnancy at an immature stage
 - b. Malnutrition
 - c. Ignorance and unconsciousness
 - d. Neat and clean
7. Which factor is the first priority to prevent the early marriage of girls like Nafiza?
- a. Including in textbook
 - b. More propagation activities
 - c. Participation of parents in awareness raising activities
 - d. Reducing the age of marriage

Read the stem below and answer questions 8 & 9.

Shila is a student of class eight. Due to her depression, she stays alone in her room all day. She doesn't get any fun from her activities and shows lack of interest in her studies. When she was taken to the doctor, he said that, 'It's not her disease but it's the problem of her age.

8. What is Shila's present period called?
- a. Childhood
 - b. Youth
 - c. Adolescence
 - d. Infanthood
9. What Shila's parents did to Shila as mentioned in the stem is -
- i. enforced strict rule
 - ii. behaved sympathetically
 - iii. behaved friendly

Which one of the following is correct?

- a. i & ii
- b. ii & iii
- c. i & iii
- d. i, ii & iii

Creative Question

1. Mr. Arif, after a few years of the birth of his daughter Tusu, observed that her behavior is different than the other normal children and she has fallen far behind for her age. She does not respond if called and repeats her speech again and again. She does whatever she thinks. She can't get along with others.
- a. What is Echolalia?
 - b. Explain why Autism is.
 - c. What type of problem is Tusu facing?
 - d. What type of impression will Tusu's behavior leave upon the society? Analyse according to the textbook.

Chapter Eight

Team Game

Games are inevitable for students at School. Games help students to develop physically and mentally and to acquire social qualities. The main aim of games and sports is physical and mental development together with enjoyment. Games and sports keep body and mind fresh and help to build character. Participation in team games helps grow as good citizens by acquiring social qualities such as team obedience, law abiding, following the leader, a sense of discipline etc.



Equipment of different games

At the end of this chapter we will be able to—

- describe the rules and regulations of games Football, Cricket, Hockey, Basketball, Volleyball, Handball, Kabaddi and Badminton;
- explain skills and techniques of mentioned games;
- explain the qualities of players of different positions in different games;
- participate in different games maintaining rules and regulations;
- develop skills in a game by acquiring qualities and skills of good players;
- develop helping attitudes through team games;
- develop leadership qualities through team games;
- develop a sense of obedience to the law of the team.

Lesson-1: Rules and Regulations of Games

Football- Football is an ancient game. In course of time this game has become a modern game. Modern football originated in England. Again rules of football were also formulated in England. Due to its huge popularity the game has spread all over the world. Though Bangladesh is a small country, still football is a very popular game here. There is an international body to control football namely Federation of International Football Association (FIFA). This organization came into being on 21 May in 1904 in Paris. With initiatives and cooperation from this organization, football has spread in many countries. As a member of FIFA, Bangladesh has popularised the game all over the country. Football is the most popular game in the world. There are 17 rules to organise and conduct the football game. FIFA ensures formulation and implementation of these rules. Therefore this game is held all over the world maintaining same rules. Players abide by the rules and the referee implements the rules properly and neutrally. So, this game has become enjoyable and exciting. The rules are discussed sequentially belows.

1. Playing field (rectangular):

Playing field is the first rule of football. The maximum length of the field is 130 yards. The minimum length is 100 yards. The maximum width is 100 yards and the minimum is 50 yards.

The measurement of playing field at international level will be-

- Length 120 yards, width 80 yards
- Length 115 yards, width 75 yards
- Length 110 yards, width 70 yards.

Any one of the above mentioned measurements of field is used for competitions at national and international level. But for school children playing field may be in length 100 yards and width 50 yards.

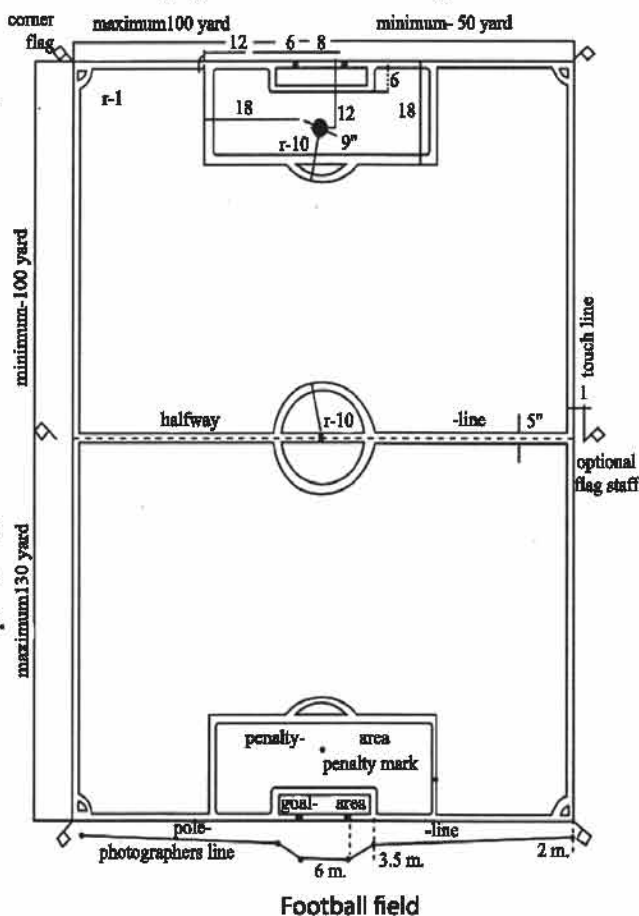

- 1.1. Line marking width:** The width of each line will not exceeding 5 inches. The name of the length line is touch line & width line is called goal line.
- 1.2. Goal area:** 6 yards from each goal post and extended 6 yards in the field of play are joined with parallel goal line. It's length is 20 yards. This area within it is called goal area.
- 1.3. Penalty area:** 18 yards from each goal post and extended 18 yards into the field of play are joined with parallel goal line. It's length is 44 yards. The rectangular area within it is called penalty area.
- 1.4. Penalty mark:** A 9 inch radius mark or which the ball is placed for a penalty kick is called the penalty mark. This mark is in-between two goal posts 12 yards away from the goal line in the field of play.
- 1.5. Corner flag:** 4 flags are put up in the four corners of the playing field. The height of the flag is at least 5 feet. The top of the flagpole will not be sharp and the flag will be on top. There will be two flags in the middle one yard away from the touch line on either side of the field which is optional.
- 1.6. Corner area:** From each flag pole or a quarter circle, having a radius of one yard is drawn inside the field of play. The corner kick is made from this corner area.
- 1.7. Goal post:** The height of the lower edge of crossbar is 8 (eight) feet from the ground and the distance between two goal posts is 8 (eight) yards. There is a net to cover the goal post from the back side. The net is hung in such a way that the goal keeper should not feel any disturbance or obstacle.
- 1.8. Center circle:** There is a circle of 10 yards radius in the middle of the mid line. This circle is known as center circle.
- 2. The ball:** The ball will be spherical in shape, it will be made by leather and similar kind of products. It will be filled with air.
- 3. The players:** A football team is formed with 18 players. Eleven members will play and seven members will be standbys or extra players and will stay outside the playing field. But in a regional or interschool football competition the number of players may be reduced.
- 4. Equipment of players:** The compulsory dress for a football player is a jersey or shirt, shorts or half pants, socks, shin guards and boots. Players cannot wear a dress or a thing that can be dangerous for others.

5. **Referee:** A person who conducts the game is known as a referee.
6. **Deputy referees:** Two deputy referees help the referee in the field. There is a fourth referee outside the field. He also helps the referee.
7. **Duration of the play:** In international or national games, for each half of the play, the time is 45 mins with an interval of not exceeding 15 mins.
8. **The start of play:** Players of both teams stay in their own half and the game will start with a kick-off with the whistle of the referee.
9. **Ball in and out of play:** When the ball crosses the touch line or the goal line through air or ground it is said to be out of play. If the ball is on touch line or goal line then it is considered to be in play.
10. **The Goal:** When a ball crosses the goal line completely may be in the air or on ground a goal is declared.
11. **Offside:** If a player stays at the opponent half without ball and two opponents are not in front of him, and in that position if he receives a ball from his teammate, he will be considered as offside.
12. **Fouls and misconduct:** There are two types of kick for fouls and misconduct.
 - a. Direct free kick
 - b. Indirect free kick. A free kick will be given if a player commits any of the following offense.
 - (a) kicks or attempts to kick an opponent;
 - (b) trips an opponent, i.e., throwing or attempting to throw him by the use of the legs or by stooping in front of or behind him;
 - (c) jumps at an opponent;
 - (d) charges an opponent in a violent or dangerous manner;
 - (e) charges an opponent from behind unless the latter is obstructing;
 - (f) strikes or attempts to strike an opponent or spits at him;
 - (g) holds an opponent;
 - (h) pushes an opponent;
 - (i) handles the ball, i.e., carries, strikes or propels the ball with his hand or arm; (this does not apply to the goalkeeper within his own penalty-area);An indirect free kick will be for following fouls:

1. playing in a manner considered by the referee to be dangerous, e.g. attempting to kick the ball while held by the goalkeeper;
2. charging fairly, i.e. with the shoulder, when the ball is not within playing distance of the players concerned and they are definitely not trying to play it;
3. when not playing the ball, intentionally obstructing an opponent, i.e. running between the opponent and the ball, or interposing the body so as to form an obstacle to an opponent;
4. charging the goalkeeper except when he
 - (a) is holding the ball;
 - (b) is obstructing an opponent;
 - (c) has passed outside his goal-area.
5. when playing as a goalkeeper and within his own penalty-area:
 - (a) from the moment he takes control of the ball with his hands, he takes more than 4 steps in any direction whilst holding, bouncing or throwing the ball in the air and catching it again, without releasing it into play, or
 - (b) having released the ball into play before, during or after the 4 steps, he touches it again with his hands, before it has been touched or played by a player of the opposing team either inside or outside of the penalty area, or by a player of the same team outside of the penalty-area, subject to the overriding conditions of 5(c), or
 - (c) touches the ball with his hands after it has been deliberately kicked to him by a team-mate, or
 - (d) indulges in tactics, which in the opinion of the referee, are designed to hold up the game and thus waste time and so give an unfair advantage to his own team,

13. Free kick: A goal that can be scored directly from a kick is called free kick. A goal that is not scored from a kick is indirect free kick.

14. Penalty kick: If any player of defending team inside the penalty area commits any fouls out of those ten fouls then opponents will get penalty kick. But the law number 10 is not applicable for the goalkeeper if it is a direct free kick.



Throwing

15. Throwing: If the ball crosses the touch line by the touch of any player the opponent team will throw the ball from that place. This is called throwing.

16. Goal kick: If the ball crosses the goal line outside of two goal posts by the touch of an opponent player, game starts with a kick. This is called goal kick.

17. Corner kick: When the ball crosses the goal line outside the goal posts by own team, the opponent will get a corner kick.

Skills of game: Football is a speedy game. It requires good physical fitness and also skills. A player having speed, stamina and skills will be a good player. Basic skills of football are as follows. 1. Kicking, 2. Heading 3. Dribbling, 4. Trapping, 5 Tackling, 6. Goal keeping.

1. Kicking: Football is played by legs. One who can acquire skills to control the ball by their legs will be able to play football. There are three sides of leg. They are inside, outside, instep. A player uses these three sides. Football player can play different types of kicks using different parts of the leg. But an inside kick that is easy and correct can give pass to the nearer player. Many times a player uses outside kick while giving pass to the right side player. That means giving pass by using the outer side of foot. Players kick hard the middle of the ball using right foot placing in their left foot left side of the ball also keeping an eye on the ball to send it straight rolling on the ground. Players maintain a balance by spreading both hands, kicking foot going straight and forward. Kicking the lower side of the ball will send it high.



2. Heading: While heading the ball, keep in mind that you have to hit the ball with forehead.



Heading

Techniques of heading

- a) Hit the ball with forehead.
- b) Keep eye on the ball.
- c) Hit the ball with forehead bending upper limbs a bit backward.
- d) Both hands will be spread a bit.
- e) While heading left or right you have to hit the ball by forehead turning the head left or right.

3. Dribbling: When a player advancing the ball step by step by kicking.

Dribblings are two types.

- a) Short dribble- to control the ball.
- b) High dribble- to cover more distance.

Exercise: Dribble the ball from one end to the other end of field. First dribble with right leg then dribble with left leg and afterwards dribble with both legs. Exercise dribbling by using different parts of leg.

4. Trapping: To control or stop the ball by other than hand is known as trapping. Trappings are many kinds such as-

- a) Sole trap
- b) Shin trap
- c) Thigh trap
- d) Chest trap
- e) Head trap.

a) **Sole trap:** To stop a rolling ball or a high ball by sole of foot is called sole trap.

b) **Shin trap:** To stop a high ball with shin after it drops on the ground.

c) **Thigh trap:** To control a high ball with the thigh. After the ball touches the thigh, the thigh has to be drawn downwards. As a result, the speed of the ball will be loosened and it will fall in the front.



Trapping

- d) **Chest trap:** To control a high ball at shoulder level with the chest.
 e) **Head trap:** To control a high ball at head height level with the forehead.

5. Tackling: Tackling is a very important defensive skill. One can snatch a ball from their opponent by using this skill. To take control of the ball from the opponent is known as tackling.

6. Goal keeping: The responsibility of a goal keeper is very high in a football game. Goal keeper can stop the ball with any part of the body. But goal keeper mainly uses his hand for stopping the ball. For example,



Goal keeping

a) **Catching the low ball:** When the ball is rolling on the ground or flying at a low height, the goal keeper will go towards the ball from behind, and bending the upper limb forward and keeping one leg one step ahead he will catch the ball.

b) **Catching low (waist) height ball:** Firstly, the goal keeper will go to the line of the ball will always keep an eye on it, catch the ball with both hands and keep the ball near to his chest.

c) **Catch the high ball:** While catching a high ball you should jump up and catch the ball with two hands keeping the palms behind the ball. Again the balls which are out of range and cannot be caught should be punched out to avoid the goal post.

Activity-1: Draw an international football field with all necessary markings and present in the class.

Activity-2: Draw and name the different parts of leg.

Activity-3: Demonstrate in the practical class which part of forehead will be used to head a ball.

Lesson-2: Cricket

The birth place of cricket is England. It is called the king's game. Cricket is an aristocratic game. Due to clean dress, day long match, lunch break, afternoon tea, gentle behavior of players, cricket is called an aristocratic game. Considering its huge popularity, there arose the need to form an international committee to formulate rules and regulations to control its publicity management etc. The representatives of the test playing countries namely England, Australia, New Zealand, South Africa, West Indies, India, Pakistan, formed a committee named International Cricket Council (ICC). in 1909. This committee is the all in all in taking decisions about international cricket. Bangladesh, Srilanka, Zimbabwe are also the test playing countries after those seven countries.

Rules of cricket: There are 42 rules for cricket game. Out of them 24 important rules are discussed below:

1. **The pitch:** Length of the pitch is 22 yards, width 10 feet. There are three stumps at either end of the pitch. Height of the pitch is 28 inches, and width of three stumps is 9 inches. Two bells are kept on top of the stumps. The height of stumps with bells is $28\frac{1}{2}$ inches.
2. **Cricket field:** Draw a half circle with a radius of 66-75 yards from the middle of the stump. Then joined both the ends, which will be the boundary line of an oval shaped field. Again draw a circle with a radius of 60-75 yards from the middle of the pitch, which is known as a round shaped field.
3. **The players :** A team is formed of 14 players when the game is played in home country and it is of 15 players when it is played abroad. Out of them, 11 players participate in the match in the field. The rest 3 or 4 players remain extra. The extra players can do only fielding. But they can not do batting, bowling and wicket keeping.
4. **The ball :** The ball will be spherical in shape. The ball will be approved both the umpire and the captain before playing. The radius of the ball is $8\frac{3}{4}$ — 9 .
5. **The bat:** The maximum length is not more than 38 inches and width not more than $4\frac{1}{4}$ inches.

6. Position of players in field: The players of fielding team take positions at different places in the field according to the strategy of bowlers. So the players of the fielding team stand in eleven places. But there are many positions in the field. Positions are as follows- Third man, deep fine leg, long leg, backward point, second slip, third slip, first slip, leg slip squire leg, gulley, cover point, short extra cover, silly mid off, silly mid on short leg, extra cover, mid off, mid on, mid wicket, long off, long on.

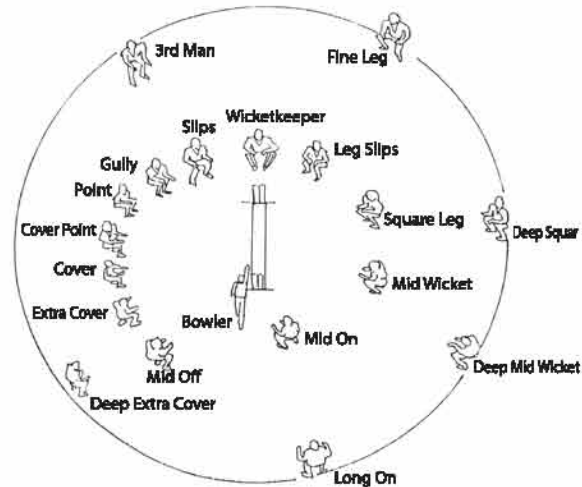

Position of players in the field

7. Over: There are six correct bowls in an over.

8. Boundary: Hit by the batsman when a ball crosses the boundary touching the ground is called boundary. Every boundary adds 4 runs to the score of the batsman.

9. Over boundary: Hit by the batsman when the ball crosses the boundary line in air is called over boundary. Every over boundary adds 6 runs to the score of the batsman. If the ball falls on the boundary it will also be considered over boundary.

10. By and leg by: If the ball crosses a distance and thereby run is collected without the ball touching anywhere of the bats or body of the batsman the umpire will signal by run. If the ball crosses a distance with touching the part of the body or the jersey of the batsman exempting the bats and thereby run is collected the umpire will signal legby.

11. No ball: When a bowler does not follow the rules of bowling or breaks any bowling rules no ball occurs. Causes of no balls are given below-

- a) If the bowler bends his elbow
- b) If delivery astride (Stop) crosses the popping crease
- c) If the bowler causes harm to wicket while bowling
- d) If the ball drops before half the pitch white bowling
- e) If the ball goes straight over the shoulder high of a batsman
- f) If the fielder position is not according to rules.

12. Wide ball: If the ball goes away from batsman, which means out of the reach of bats man, it is called a wide ball. There is a difference of distance between wide ball of one day and test cricket.

13. Run out: If the fielding side makes the ball fall on the ground before the batsman who is taking runs fails to return to the crease, the batsman is called run out.

14. LBW: When the umpire thinks that the ball could have hit the stumps if not blocked by the batsman's legs, the umpire may declare the batsman out following the appeal by the opponent. This is called leg before wicket (LBW).

15. Bowled out: When the ball directly or shot by the batsman hits the stumps and displaces the ball the batsman is declared out. It is called bowled out.

16. Caught out: When the batsman hits the ball in the air and a fielder catches it before touches the ground, that batsman will be out and it is called caught out.

17. Stumped out: When the batsman goes outside the crease to play ball excepting no ball and the wicket keeper breaks the stumps, the batsman is declared out. This is called stumped out.

18. Timed out: When a batsman fails to take guard within 3 minutes of a wicket fall, he will come under the rules of timed out. For T20 duration of timed out is 1¹/₂ minutes.

19. Hit wicket: While playing, if the batsman hits the wicket by his body, dress or bat and the ball falls, the batsman will be out. This is called hit wicket.

20. Hit the ball twice: When the batsman hits or touches the ball with his body or bat, he can't hit the ball again to save his wicket. If he does so, he will be out and it is called hit the ball twice out.

21. Hold the ball intentionally: If the batsman holds the ball or play the ball or obstructs the ball with his hands intentionally, the bats man will be out under the rules hold the ball.

22. Obstructing the fielder: If the batsman intentionally obstructs the fielder, when fielding the ball, he will be out for obstructing the fielder.

23. Century and half century: When a batsman scores a hundred runs by playing ball he is said to have made a century and if he scores a fifty he is said to have made half century.

24. Maiden over: When a bowler bowls so perfectly and the batsman cannot

score any run in an over, that over is called a maiden over and in that over if the bowler takes any wicket, this is known as maiden wicket.

Skills: In cricket skills are mainly divided into four categories, they are

- a) Batting
- b) Bowling
- c) Fielding and Catching
- d) Wicket keeping

a) Batting: Basic skills are grip, stance, back lift, stroke, gloves, drive and hook. The batsman can entertain spectators by the correct application of their skills. The batsman can also score runs fast or hit boundary using these skills and spectators enjoy the game.

1. Grip: In batting, grip is very important. Proper grip helps the batsman to play stroke on both sides of the wicket. For the right handed batsman, the position of the left hand will be on top of the bat and the right hand will be under the left hand. The batsman grips the bat with both hands together side by side and holds the handle of the bat with fingers and thumb. The shape of index finger and thumb will be like English letter V.

2. Stance: A right-handed batsman stands, keeping the left leg facing the bowler and the right leg inside the popping crease, knee will be flex. He will stand comfortably, keeping his body weight on both legs. His left hand will be his above left thigh and the left shoulder and the eye will be on the bowler.

3. Back lift: Lifting the bat back is very important for batting. The batsman's eyes will be always on the bowler and his shoulder and elbow should be facing the bowler.

4. Stroke: The batsman has to play different types of stroke according to the merit of the ball. Sometimes he plays defensive strokes and sometimes offensive strokes. A batsman puts his leg one step forward keeping an angle of bat 30° - 40° and plays a defensive stroke. It is known as forward defensive stroke. The position of bat at that time will be like the English letter "v".

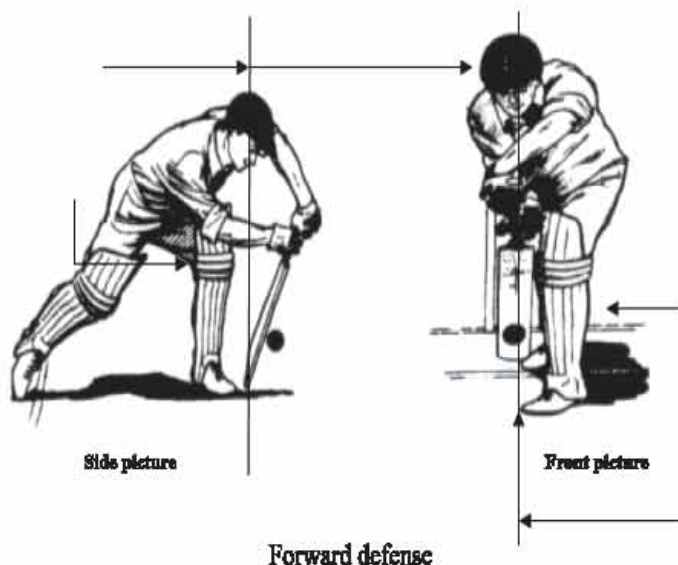

Again the batsman plays a stroke putting one step backward known as backward defensive stroke.

5. Drive: Offensive and attacking batting is always enjoyable to spectators. A batsman usually puts one step forward outside the popping crease and hit the ball hard to cover more distance. This is known as forward drive.

6. Hook shot: When the bowler bowls a short pitch ball, it drops away from the batsman and bounces high. While playing a hook shot, a right-handed batsman keeps his body weight on his right leg and hits that high-bounced ball in the air sending the ball to his on side. A batsman has to make use of his eyes, hands and legs very fast in order to play a hook shot. But it is a risky shot to play. Without expertise one should not play a hook shot.

7. Cut shot: When a bowler bowls a short pitch ball, the batsman puts his leg one step forward or backward and plays the ball. This skill is known as cut. Beginners should not practice this shot. Shot selection is very important while playing cuts. A batsman should go to the line of ball when the ball passes two feet away from off stump and plays a cut shot by cutting the ball.

8. Leg glance: In this stroke a batsman has to use his wrist and hand very forcefully. After play, the shot leg glance ball usually travels towards square leg and fine leg. Leg glance is played in two ways: first, while stepping forward outside the popping crease and second, stepping back, towards. This wicket leg glance is played by moving legs leftward or rightward according to ball.

b) Bowling: In cricket bowling is one of the main skills. The batsman cannot score or cannot do well against a very high standard of bowling. A batsman may be out soon against attacking bowling and as a result, a team can easily win in a competition. Some basic skills of bowling are given below.

1. Correct grip to hold the ball: The grip of ball will depend on the type of bowling. The grip of fast bowling and of spin bowling are not the same. But the grip of any type of bowling will be with the help of fingers not with the palm. So, the bowler can control bowling.

2. Run-up: The bowler comes running to deliver the ball from bowling crease towards the batsman. This process of running is very important. Bowling speed largely depends on running speed. A batsman cannot easily play a ball with high speed. A bowler uses his feet into a fix distance of run up. At the time of

run up the body weight of the bowler is inclined forward.

3. Delivery: Leaving the ball at the end of a run up is called delivery. A right-handed bowler at the time of delivery jumps on his left leg and twists the body rightward and lands on the right leg. He fondly delivers the body keeping an eye on the batsman.

4. Follow throw: After delivery of the ball the bowler maintains the balance of his body in a specific way which is known as follow throw. After delivery of the ball a bowler has to move his body fast from right side to a straight position, keeping his eyes on pitch, where the ball drops.



Grip of fast bowling

Fast bowling

1. Fast bowling in swing: In fast bowling to do in-swing ball is easy. But to maintain line and length every time is not easy. If a bowler cannot maintain line and length he has to give more runs. The characteristics of a swing ball are the ball falls slightly outside the off stump and swings inside towards the stumps very fast. The thread line of the ball will be kept in between index and middle fingers. At the time of delivery the thread of the ball faces leg slip and the right hand (elbow) goes upward and the left hand goes downward. Usually from swing back fielders get catches at short leg position.

2. Fast bowling out swing: The grip of fast bowling out swing is similar to fast bowling in swing. The thread will be in between index finger and middle finger and other three fingers will be under the ball. But the thread faces towards first slip.

Spin bowling

1. Leg spin: Spin is mainly two types, (i) Side spin (ii) Top spin.

(i) Side spin bowling: In side spin ball, the bowler spins the ball clock wise and anti clockwise both ways. When a right-handed spin bowler bowls a right handed batsman, the ball moves anti clockwise and the ball becomes leg break.

Again when the ball moves clock-wise that is it an off break ball. Top spin is a combination of leg break and off break. In spin bowling at the time of delivery, wrist and the arm move in 90° angles. Usually in leg spin, ball falls on the pitch on the line of leg and then turns towards off stump. In leg spin the grip of the ball is on between index, middle and ring fingers and the thumb helps to hold the ball. At the time of delivery left shoulder will not be downward. The wrist will be flexing and the third finger will help to spin the ball.

(ii) Off spin: In off spin bowling the index and middle fingers will be placed across the thread of the ball, while the tips of two fingers will be a little apart. The thumb will be on the thread and two other fingers will be together below the ball. The index finger will be on thread of the ball and moving downward will spin the ball. Off spin ball will move clockwise. The function of wrist in off spin bowling is similar to its function in opening the knob of a door.

(iii) Gugly : If the leg spin bowler delivers off spin in the same grip , it is called gugly.

c. Fielding and catching: In cricket, fielding can also be attractive like batting and bowling and it also can play an important role in win and defeat in the game. When a fielder takes a catch of a batsman, spectators enjoy that catching. Every cricketer has to be a good fielder. Positions of the fielder are determined by the choice of the captain or the bowler. Usually a fielder sends back the ball to the wicket keeper. In fielding, catching is a very important skill. The fielder has to under the line of ball when the batsman hit the ball high and always has to keep an eye on the ball. Both hands will be open and fingers are placed side by side, palm and finger will be flexible. As soon as the ball touches the hands, usually the hands will be pulled close to the chest and fingers will be closed. Apart from catching a fielder has to stop pick and throw the ball.

Throwing: In attacking fielding the fast and correct throw is very important. As a result, even a good batsman can be run out. Also it can decrease the run rate of the batting side. For a good throw, players have to use flexible wrist, hand and shoulder. The technique of throwing after catching the ball is to take the initiative only after the ball comes to the hand. For a throw, the wrist, the hand, the shoulder and two longs have to work together.

d. Wicket keeping: The position of the wicket keeper is very important among all the players in the field. For this reason, while selecting the best wicket keeper the selectors have to look for their qualities in him like sharp eyes, fast reaction, strong hands, physical strengths and courage. Generally it is considered that wicket keeper is born, he cannot be made. The dress and the equipment's of the wicket keeper is different from that of others players. They are wicket keeping pad, gloves, inner gloves, cap, guard, shoes, this are the dress and equipment of a wicket keeper. The wicket keeper has to take a stance like a batsman. Because he has to be ready for all the time to catch the ball coming from the bowler, or the batsman, has to stand or half-seat keeping legs apart, place his body weight on both legs, keep his body a bit low and an eye on the wicket. His left leg will be in front of middle stump hans, are side by side together, fingers are downward and eye on ball.

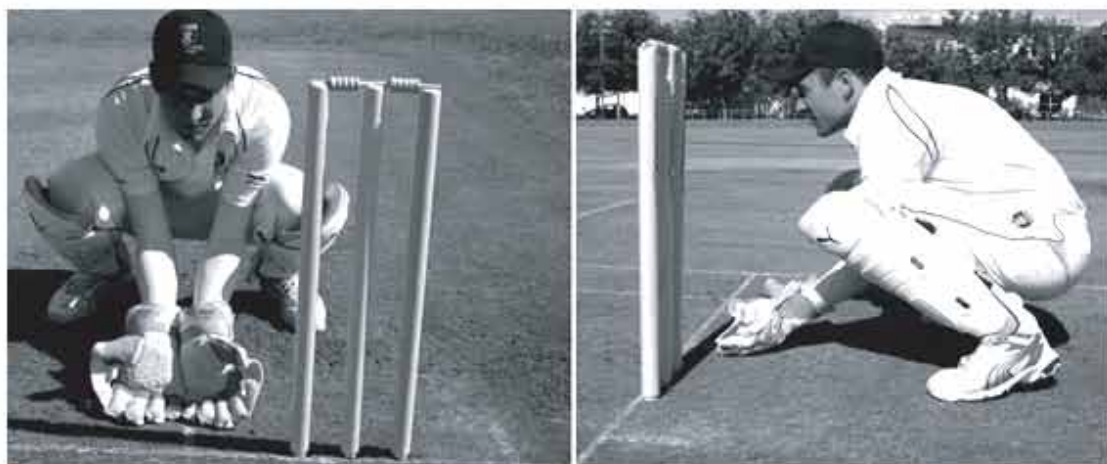

Wicket keeping

Activity-1: Discuss and demonstrate the differences between grip of fast bowling and spin bowling.

Activity-2: Demonstrate the stance of batsman in field.

Activity-3: Show the position of wicket keeper during fast bowling and spin bowling.

Lesson-3: Badminton

There are different opinions regarding the origin of badminton but most of agree that it was born in Pune of India. English soldiers at Pune in early 17th century observed and felt interested to see the local people playing the shuttle cock with a short bat. They learned that game from local people and went back to England during leave and started playing and introducing this game at Badminton. Then according to the name of that place the game named as Badminton. The game was introduced in many countries for all aged people and classes both male and female.

a. Playing court: The floor of the court should be made of wood but it should not be at all slippery. The shuttle is white in colour, so the floor of the court will be deep coloured but not shiny. If the colour of the floor is other than white marking of court will be black, otherwise the colour will be white. Badminton games are two types (i) Singles and (ii) Doubles. Measurement of single court length is 44 feet, width 17 feet. The court-Length for Doubles 44 feet and width 20 feet. The badminton net is hung on the poll outside, middle point of both end lines. There are two parallel lines 6' 6" away from the midpoint of both sidelines known as short service line. Again there are two parallel lines 2 feet and 6 inches inside the court from end line which are known as long service line. This is used in doubles game. A line from short service line to the end line of both sides divided the court into two courts named right service court and left service court. All the markings will be 4 cm. in width.

b. Equipment

1. **Post:** Height of the court is 5' 1".
2. **Net:** The length of the net is 17'(feet)and width 2' 6". The height of the net from floor to both posts is 5' 1" and in the middle hight of the net is 5'(feet). The top of the net will be with a white tape of width 3"(inches)and there will be a rope or string inside the tape which will be fixed with the post from both sides.

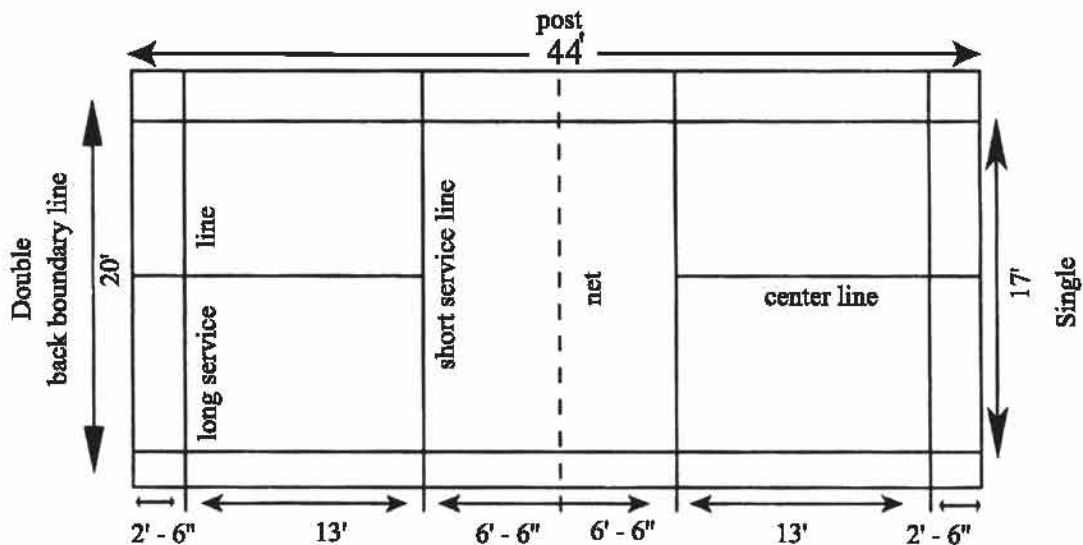

Measurement of Badminton court, singles and doubles

3. Racket: The length of the handle of the racket is 26 inches. The racket has a net on the upper side of it. The net will be taut in its position.

4. Shuttle cock: The shuttle cock is made by duck's feather. All feathers are tied with thread. If a player hits a shuttle cock with the racket and if it falls near long service line of the opponent court the shuttle cock is considered standard one.

Rules

- 1. Toss:** If the team of players win the toss they can take service or court.
- 2. Point:** In singles and doubles the game will end at 21 points. But there should always be a difference of at least two points to finish the game. For example 19-21, 20-22, 22-24-this way. But not exceeding 30 points. The team that gets 30 first, they will be the winner. In the third set, players will change their court after scoring 11 points.
- 3. Service:** In single games, for both male and female the player who will commit a mistake will lose the service. In double games for male and female, team first taking service will not get chance for second hand service. If a team the commits any mistake the opponent will get service which will be done diagonally-not straight.

4. Service fault: Service faults occur for the following reasons.

- a. If the shuttle does not travel diagonally
- b. During service if a leg is lifted above from the court the service is faulty
- c. If the shuttle fall on short service or long service area
- d. If the shuttle goes out of the court
- e. The shuttle should not be free from hand
- f. The shuttle should not be above waist height
- g. If the shuttle does not cross the net
- h. During service if a player touches the marking of the court
- i. If a player intentionally deceives the opponent during service.

5. Let: If any unforeseen accident takes place during the game the umpire can declare a let. For example, if the server serves before the receiver is ready or if both the players commit a mistake simultaneously

6. Five types of competitions in badminton. They are-

- a. Male single
- b. Male doubles
- c. Female single
- d. Female doubles
- e. Mixed doubles

7. There should be one referee, one umpire, one scorer and two or four line judges in a badminton game.

Skills of badminton: Badminton skills are divided into four types.

They are-

(i) Grip, (ii) Footwork, (iii) Service, (IV) Stroke and smashing

1. Grip: A player should learn how to grip the racket, which is essential for every player. In griping the wrist plays an important role. There is a difference in griping while taking a forehand and back hand short. So, grips are divided into two types. They are (a) forehand grips and (b) backhand grips.

- a. **Forehand grip:** A right-handed player, plays all the shots from his right side with a forehand grip. A player holds the racket with the thumb and the index fingers in such a way that it looks like an English letter 'v'.
 - b. **Backhand grip:** A right-handed player plays all the shots from his left side with back hand grips. In this grip, the thumb will be placed on the handle diagonally. Last part of the handle of the racket will be held with palm.
2. **Foot work:** Good foot work is necessary to take a quick stroke. A player's foot work has to be good to take a stroke forward, backward, sidewise, with jump and run. A right handed player has to stand with the flex left foot ahead and right foot a bit back and knees a little flex to receive a service or to do a service. At this time the body weight of the player rests on toes. Feet are kept at a distance of 14"-18" This position of a badminton player is called stance. Apart from this a player can pivot his one leg and move around the other to perform foot work.
3. **Service:** A good player should know three types of service. They are (a) High deep service, (b) Low service, (c) Drive service.
- a) **High deep service:** When a service falls near the long service line of the opponent court travelling very high, it is called high deep service.
 - b) **Low service:** When the shuttle travels very low to the near short service line of the opponent court it is known as the low service. At that time the racket is held with forehand grip.
 - c) **Drive service:** If the shuttle travels low and fast right back to the receiver, it usually hits hard, so it is known drive service.
4. **Stroke and smashing:** The skills of stroking or hitting skills are divided into six types. They are-
- a) **Forehand stroke:** The right-handed player keeping left leg and left shoulder towards the net, hits the shuttle from right side. His body weight will be on the right leg while taking the racket back. After hitting the shuttle his body weight will be shifted from the right leg to the left leg.
 - b) **Back-hand shot:** The right-handed player will hit the shuttle from left side. He will keep his right shoulder and leg towards the net.
 - c) **Overhead shot:** Firstly, keeping the left foot a bit forward and the body weight on the right leg, the player usually hits the shuttle bending his upper part a little backward. He will keep an eye on the shuttle and pull the racket from back to play an overhead shot.

- d) Drop shot:** The technique of a drop shot is that the shuttle will drop in the other court, crossing the net very narrowly.
- e) Underhand drop shot:** Swing the racket during service after it touches the shuttle and control the speed of racket.
- f) Smashing:** Smashing is basically an overhead shot. In an overhead shot position, swinging the hand with the racket from back to upward, a player hits the shuttle hard downward. It is called smashing.

Activity-1: Draw a badminton court and display in the class room.

Activity-2: Practice techniques of different grips as per instructions of the teacher.

Activity-3: The class will be divided into two groups. One group will tell the faults of service and the other group will correct them where necessary.

Lesson-4: Volleyball

Volleyball is a team game which people of all ages can play in an open space or in a gymnasium. This enjoyable game originated in the United States of America. William G. Morgan, director of physical Education department at YMCA college Holywook, USA, first invented the volleyball game in 1895. The teachers of physical education department at Spring Field college, USA, considering its similarity with “volley” named it volleyball in 1896. In 1897 YMCA first formulated and published volleyball rules. On 20th April 1947, Paul Lebort took the initiative to form an International Volleyball Federation. After independence a volleyball federation was formed in 1972 in Bangladesh.

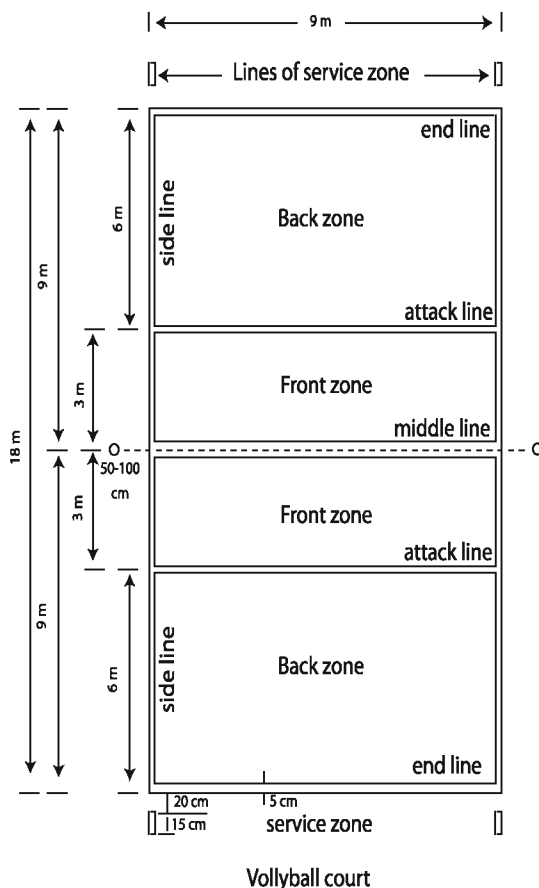

a) Rules and regulations of volleyball

- 1. Playing court:** The volleyball court is rectangular, whose length and width are 18 meters x 9 meters respectively. There will be no obstacles up to 7 meters in height from the floor.
- 2. Boundary line:** The boundary of the court has to be marked around it by a 5 cm wide boundary line. 2 meters away from the boundary line have to be free from any obstacles.
- 3. Centre line:** A line joining the two side lines of the court making the court to equal halves is called the centre line. The centre line lies under the net.
- 4. Attack area:** There are two parallel lines 3 meters away from the centre line, whose two ends will meet the two sidelines of the court. The two courts created by the centre line will have two attack areas, each having an area of 9X3 meters.
- 5. Service area:** The whole area behind the back line is known as service area. A line will be drawn 15 cm. at the distance at 20 cm. from the back line.
- 6. Temperature:** If it is an indoor court the temperature will not be less than 10° C or 50° F.

b) Net

- 1. Measurement and structure:** The length of the net will be 9.5m and the width one meter. Each square of the net will be 10 cm. There will be a white canvas tape of 5 cm on top of the net. A wire or string will go into the tape, which will fix both sides of the net with the poles.
- 2. Height of net:** The height of the net from the floor, in the middle will be 2.43 m for male and 2.24 m for female.
- 3. Side marker and antenna:** From the point where the side line and the centre line meet together, a tape of 5 cm width will be hanging, which may be moved when necessary. There are two antennas of 1.80 m in length and 10 mm in diameters made from fiber glass or similar metal will be hanging. That tape will be tied from both sides with the net.

c) Ball, players, and equipments of players

- 1. The ball:** The ball will be made of soft leather. It will be round shaped. There is a soft bladder inside. The radius of the ball will be 67 cm .

2. The players: A volleyball team consists of 12 players. One member of the team will be appointed captain. There is an badge on the left side of the chest of the captain.

3. Dress and equipment of players: The jersey, shorts and light and flexible shoes without heel are the dress of a player. The colour of the dress for all players of a team will be the same. There will be jersey numbers on chest and back of different colour. The colour of the numbers will be different from that of the jersey.

4. Position of players: Six players will take position in the court. Of them 3 players will be in the attacking area and the other 3 are back court players, Before the beginning of the game, the information regarding players positions and rotation should be given to the umpire so that they can maintain the same rotation until the game is over, but the order of the rotation may be changed at the beginning of each set.

d. Play

1. Preparation of game and toss: The referee will toss a coin in the presence of both captains before entering the court, and the winning captain will choose service or court. There is 3 minutes for warm-up for both teams. Substitute players and coach will sit on specified place opposite to the referee.

2. Rotation: In volley ball players will maintain rotation clock wise. Rotation will take place after the opponent loses service. The referee will take necessary measures to punish the team in regard to faulty rotation.

3. Time out: At the request of the captain or the coach, referee can grant time-out when the ball is out of play or dead. Every team will get time-out twice in each game and can take temporary interval for substituting 6 players. During the time out a player can come closer, to the side line but cannot go outside the court.

4. Substitution: Six players play in court, and the 6 additional players and the coach will sit in specified place. At the request of the coach or the captain, these additional players may be substituted for court players.

5. Officiating: One referee, one umpire, one scorer and two line judges conduct the game. The referee's decision is final from the beginning to the end of the game. The referee sits at any site of the net on a high place at least 50 cm above the net height, so he can see all the places of the court.

6. Court change: After the end of each set, players will change the court except the final set. In final set, if any team scores 8 points both teams change court.

7. Results of game: At the end of the rally if the serving team wins, the team will get one point and if the serving team loses, the opponent team will get a point and service. In this way the team that will first score 25 points will win the set but with a point difference of at least 2. If the points of both teams are equal than the game will continue until there is a difference in 2 points. If a team wins 3 sets out of 5 sets, that team will be declared winner in the competition. In the final set the game will be completed in 15 points.

8. Service: The player of extreme right will serve according to rotation. The player will stand in the service area and toss the ball above and hit it to send it to the opponent court. However, service will be done only after the referee's signal. If ball crosses the court under the net, or touches the net or the antenna of the net or goes outside the opponent's court it will be a faulty service and the opponent will get service.

9. Playing the ball: After service, each team will get three chances to play the ball within this three touches a team has to pass the ball to the opponent's court. If the ball touches any part of the player's body, it will be considered as one touch. In the time of playing passes the ball with pressure pushing and pulling by hand is called holding.

10. Block: To protect the smash of the opponent player or more players in the front line can raise their hands to block the smash. Players in the back line cannot participate in block.

11. Ball on net: Except the service ball, other balls can touch the net while crossing the net.

12. Crossing the centre line: During play, any part of player's body can not cross the centre line and cannot touch the opponent's court or cannot block anybody.

Technique of playing volley ball

a. Service: Tossing the ball up with hand and hitting it by the other hand, to send the ball to the opponent's court is known as service. If the serviced ball

does not pass under the net, does not touch the net, does not go out of the opponent's court the service is considered correct.

Generally service is of two types. They are (i) Under hand service (ii) Tennis service

1. Under hand service: The player will have to stand facing the opponent court inside the service area, placing one foot forward and the other foot backward. The two feet will be placed a little apart. The body weight will be on back leg, with knees bending a little forward. Keep the ball on the palm of the left hand and keep the right hand backward. Then toss the ball upward in the air and hit it forcefully with the right hand. While hitting the ball the right hand may be closed or open.



Under hand service

2. Tennis service: The player stands in service area. If he is a right-handed player, his left foot will be one step forward. Keeping his body weight on both leg. Tossing the ball high above head height a little bit forward he will hit the ball with right hand to send it to the opponent court. After hitting ball his right leg will come forward as a follow throw.



Tennis service

b. Position of rotation: There are six players and if the number of the players is 1 to 6 then three players will stand in the front court and other three will be in the back court. The positions of the players are shown in the picture. In the front court, 3 players will stand. Player no-2 will be on the right side of the front court, player no-3 will stand in the middle position and 4 will be on the left position. In the backcourt, player no-5 will be on the left, player no-6 in the middle and player no-1 will be on the right.

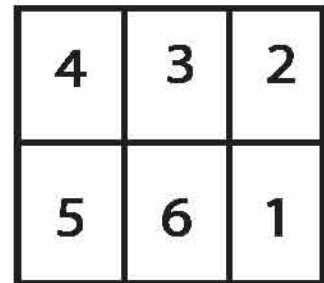

Rotation

If the opponent loses service then rotation will take place. Player no-1 will be in the position of player no-6 and so on. Every player will change his position. The rotation will be clock wise and the arrangement will be anticlock wise.

c. Passing: Generally passing is of two types.

(1) Over head pass. (ii) Under hand pass.



Smashing

d. Set-up: The volley pass (under hand pass) for a front line player to smash across the net is called the set-up pass. It is said that attacking strength will depend on his ability to place these set-up accurately.



Ball passing

e. Smashing: The ball for smashing must be above the net height. Smash will take place 3-4 steps behind the ball from where the ball will be hit. From that position the smasher will run 3-4 steps and jumps up

and will take the body behind the ball. One will bend both hands so that one can jump high. Smashing hand will swing from back and hit forcefully. He will land on both legs straight downward. Sometimes to misguide the opponent he will push the ball other side in spite of smashing.

f. Blocking: To form a block, the front line players of defending team jump vertically opposite the smasher and place a wall of hand in the path of the ball, hoping to deflect the ball into his court. At the time of block, players jump on both legs, keeping in mind that during block the net cannot be touched.



Blocking

Activity-1: Draw a diagram of the system of rotation.

Activity-2: Show the techniques of tennis service.

Activity-3: Show the techniques of block.

Lesson 5: Kabaddi

Kabaddi is an ancient and popular game of indo-pak subcontinent. In this subcontinent, it is played in different areas in different names. There are no set rules for this game as it is a regional game. In villages, the kabaddi or hadudu game is the only source of enjoyment. The traditional game of Bangladesh hadudu is known as Kabaddi. After independence to gain momentum in games in Bangladesh, different federations are reformed. So in 1973 Kabaddi Federation was formed. With the assistance of kabaddi federation, kabaddi was included in the SAF games in 1984 in Dhaka. From that time kabaddi games have started in the international sports arena. In 1990 kabaddi games were included as regular games in the Beijing Asian games. We shall hope that this game will be included in the Commonwealth and Olympic games very soon.

Kabaddi: The field will be rectangular and soft. It will be prepared by mat or mud. There are three kinds of kabaddi fields, such as-

1. Men and Junior boys
2. Women and Junior girls
3. Sub-Junior boys and girls.

1. Men means those males whose body weight is 80kg or below. Junior boys body weight will be 65 kg or below and their age not above 20. For them field measurement is-length-13 meters and width-10 meters. (with lobby)

2. Women means those females whose body weight is 70 kg or below not be above 20 years and girls whose body weight will not exceed 60 kg. The field for them is-length 12 meters and width 8 meters. (with Lobby)

3. Sub-junior boys and girls whose age will not be more than 16 and their weight is 50 kg or below. The field for them is-length 11 meters and width 8 meters (with lobby).

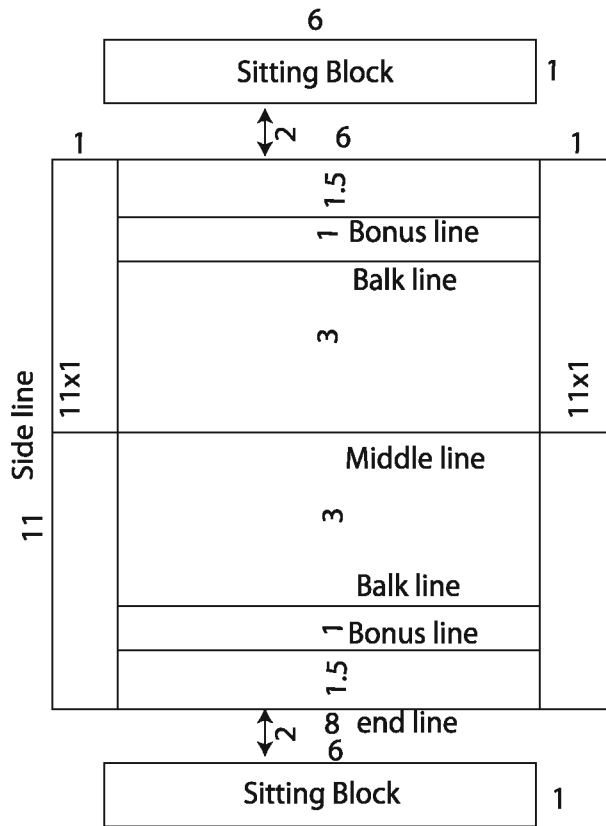

Kabaddi field (Sub-junior boys and girls)

Playing area (Court): Before struggle, the court for men and junior boys, without lobby on both sides, will be length-13 meters x width 8 meters. Women and junior girls' field will be length-12 meters x width 6 meters and sub junior boys and girls' field will be length 11 meters x width 6 meters.

Sitting blocks: Dead players sit on the restricted area known as sitting blocks. For male and female players this blocking area at a distance of 2 meters from the end line 1.8 and 1.1 meters away from end line there will be two more blocking areas 1.8 meters and 1.6 meters from the end line for women and junior girls respectively.

Lobby: The space on either side of the court with one meter width is known as lobby. Lobby will be inside the field if it is struggle.

Mid line: The line which divides the court into two courts is known as mid line.

Court: Each half of the field which is divided by the mid line is called the court.

Balk line: A line parallel to the mid line inside the field is known as balk line. Distance from the mid line is 3.75 meters for men and junior boys, women and junior girls the distance is 3 meters and for sub-junior boys and girls the distance is 3 meters.

Bonus line: A line parallel to the end line and 1 meter towards balk line is called the bonus line.

Holding the breath: A player holds his breath and starts saying rapidly, clearly, and loudly “kabaddi-kabaddi” is known as holding breath.

Raider: A player hold his breath and send into the opponents court is known as raider. Raider has to hold his breath before entering the opponents court.

Anti raider: The entire players opponent to the raider are called anti raider.

Breath lost: If a raider does not utter “kabaddi kabaddi” rapidly, clearly and loudly or he is not holding breath then it will be considered he lost his breath.

Touch or kill anti raider: If a raider without breaking any rules or without violation of rules, touches ant raider’s any part of the body and comes back to his own court the anti raider will be considered out (kill).

Catch raider: If a raider is caught without violation of any rules, until his breath of until the referees whistle then the raider is considered out (kill).

Touch: If the raider touches the dress of any anti raider it will be considered he touched the anti.

Struggle: When the anti or antis come into contact with the raider it is called struggle. During struggle lobby also considered as court.

Playing rules

1. Wining captain will chose raid/court, other captain will take the rest one. The players will change court in the second half. If a team takes raid at the beginning of the game, in the second half the next or the other team will get chance to start the game with raid.

2. If any body part of a player touches the ground outside the boundary line, he will be considered as dead.
3. a) During the game if any player is out of the boundary line, he will be out. The Umpire/referee will call his name, that player will be out of the court. The referee will not blow the whistle and the raid will be continuing, that means the game will not stop.
b) During the raid if an anti or antis go outside the boundary line and catch the raider, then the raider will not be out.
4. At the time of struggle the lobby will be part of the field. During struggle or after struggle, the players who are involved in struggle can return to their court using the lobby.
5. The raider will hold his breath with saying kabaddi, but if he does not utter kabaddi correctly, then the referee will call him back and the opponent will get one technical point.
6. The raider will hold the breath before touching the opponent court. If he holds his breath late or after/the umpire will call him back and the opponent will get one technical point. The raider also gets a chance to raid again.
7. If the raider starts raiding and enters into the opponent court without having his turn. The referee will call him back and the opponent will get one technical point.

Rules for competition

- 1. Team.** There are at least 10 players and at best 12 players in a kabaddi team. Seven will play in the field and the others will be the substitute players.
- 2. Duration of play:** For men and junior boys, each half will be 20 minutes with 5 minutes interval. For female or junior girls and sub junior boys and girls, each half will be 15 minutes with 5 minutes interval. The players will change the court after interval. In the second half, the number of players will be unchanged- the same number and the same players will be on the court.
- 3. Point counting:** For each dead player the opponent team will get one point and if all players of a team are dead the other team will get lona and additional two points.
- 4. Time out:** a) Each team will get time out twice in each half. The duration of time out will be 30 seconds. The captain, coach, trainer, or any player of a team

can take time-out with permission of the referee. The time-out time will be added to the duration of game time.

b) The player cannot leave the court during time out. For violation of this rules the opponent team will get one technical point.

c) Reasons for official time out are as follows- i) if a player is injured

ii) Field marking is needed again

iii) If the game is interrupted by outsiders or by similar other things the referee/umpire will declare the final time out. This time is also added to the duration of game time.

5. Substitutes

a) With permission of the referee additional five players can be changed during time out or in the interval.

b) A substitute can play again.

Techniques of kabaddi game: There are two types of skills in Kabaddi game. They are (i) Defensive skills and (ii) Offensive skills.

1. Defensive skills: Anti raider or the players of a court who are holding the breath are said to have adopted defensive skills. For example-

- a) Catch the heel
- b) Catch the knee
- c) Hold the waist
- d) Catch the wrist
- e) Catch with chain etc

a. Catch the heel: Generally the opponent applies this technique when a raider tries to touch the anti-raider with a foot. The player of left side use this technique standing left leg ahead, catching leg the raider leg with the right hand.

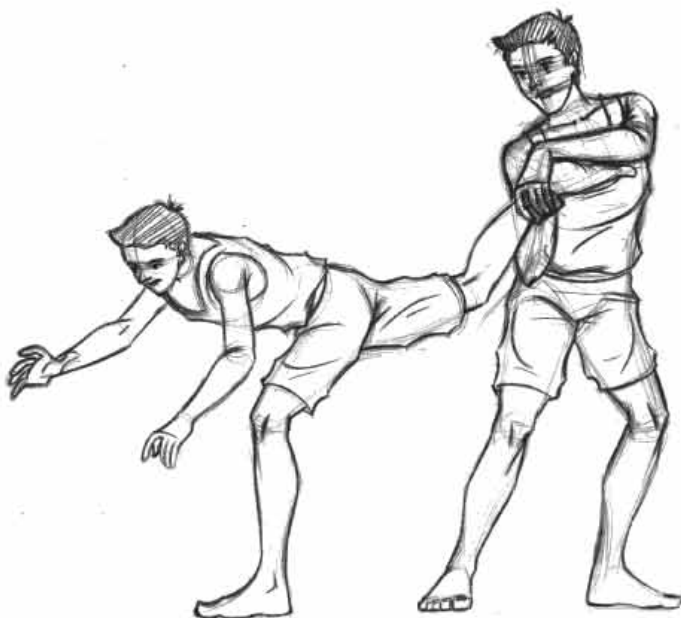

Catch the heel

They put their left leg ahead and catch the feet simultaneously. After the catching heel, the leg is pulled up to the chest and pull his body.

- b. **Catching the knee:** The players apply this technique when a raider tries to touch with legs or his legs become stable after movement or when both legs are together. The left side player, keep the left leg ahead and the right-side players keep their right hand ahead also keeping their left hand down and right hand above the knee and hold the raider with both hand and shoulder together.
- c. **Catching (Holding) the waist:** Anti raiders use this technique when a raider stands showing back to the opponent. After holding his waist they lift him a bit high, that means above the floor.
- d) **To catch wrist:** When a raider touches with hand or when his hands are stable, then the opponent catches his wrist.

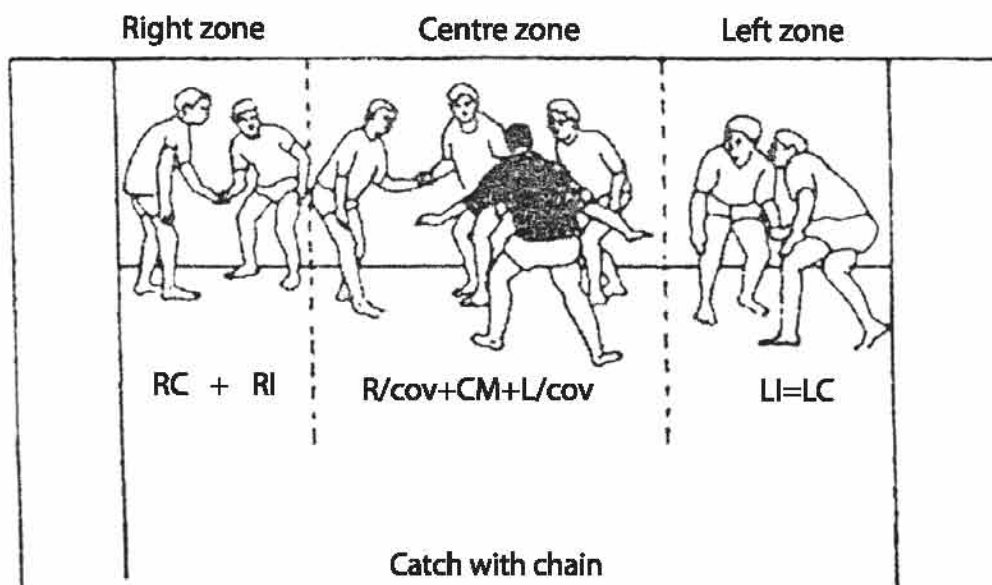

- e) **Catch with chain:** Catch with chain is very effective. Most of the trainers give a very high emphasis to catching with chain. Time of raiding the raider leaning his body to the opponent then this techniques will be applied.

2. Attacking skills: A raider applies some skills to touch the opponent when he raids in the opponent court. All these skills are known as attacking skills. For example, touch with leg, touch with hand, touch with fake.

- a. **Touch with leg:** When a raider tries to touch the opponent with his leg, it is called the touch with leg. There are different techniques used to touch with leg.
- b. **Touch with hand:** When a raider try to touch the opponent with a hand, there are different techniques to do that. They are from top to downwards, bottom to up from front to side and from side to front etc. Generally the raider use a hand to touch the opponent's nose, ear, and head or any of the upper part of the body.
- c. **Fake and touch:** When a raider fakes to touch the opponent and tries to touch, it is known as fake and touch. This technique is very effective. Most of the raiders try to touch the opponent, applying, this technique.

Officials: There are 6 officials to control the kabaddi game.

1. One referee. 2. Two umpires, 3. One scorer 4. Two assistant scorers

Referee: The referee is all in all in the field. He will start and finish the game. If there is any difference of opinions he will take the decision.

Umpire: An umpire maneuvers the game.

Scorer: The scorer writes scores declared by the umpire.

Assistant scorer: An assistant scorer assists the dead players to sit in the proper place and helps them to enter into the court according to rules.

Serious violation of rules and fouls: If a player commits the following fouls, the referee or the umpire can give a caution and give a point to the opponent. He can also expel a player or declare him unfit.

1. To persuade them to take decision
2. To criticise a decision
3. To raise finger to take a decision in favor.
4. To hold or press mouth of a raider to stop his breath
5. To play dangerously so that the opponent be may be injured
6. To take more than 5 seconds to start a raid
7. To catch a player with both legs like scissors.
8. To train a player from outside the field
9. To obstruct a raider to breathe

Bonus point: If a raider crosses the bonus line the raider team will get one bonus point. But at least 6 players have to be in the court.

Lesson-6 : Basketball

Basketball first started at Massachusetts in America in 1881. Dr. James Naismith Director, department of physical education of Spring Field YMCA college of America first introduced this game. At the initial stage 10/15 players used to take part in the game. In 1894, basketball was first played by five players. Basketball first started in Bangladesh by the Christian missionary schools, such as St. Gregory's school, St. Joseph school of Dhaka and st. Placid school of Chittagong. Endurance is required to play this game.

Rules of Basketball

1. Court: The basketball court is rectangular. It's floor will be wooden or hard without any obstacles. The measurement of basketball court for national and regional levels: length will be 26 meters and width 14 meters. For international competition: length will be 28 meters and width 15 meters.

2. Circle of court: There are three circles in the court, each with a radius of 1.80 meters.

3. Restricted area: A circle (with 1.80 meter radius towards playing area 5.80 meter away) from the midpoint of end line and two marks on both side of end line from the midpoint of end line add with the diameter of the circle which is known as restricted area.

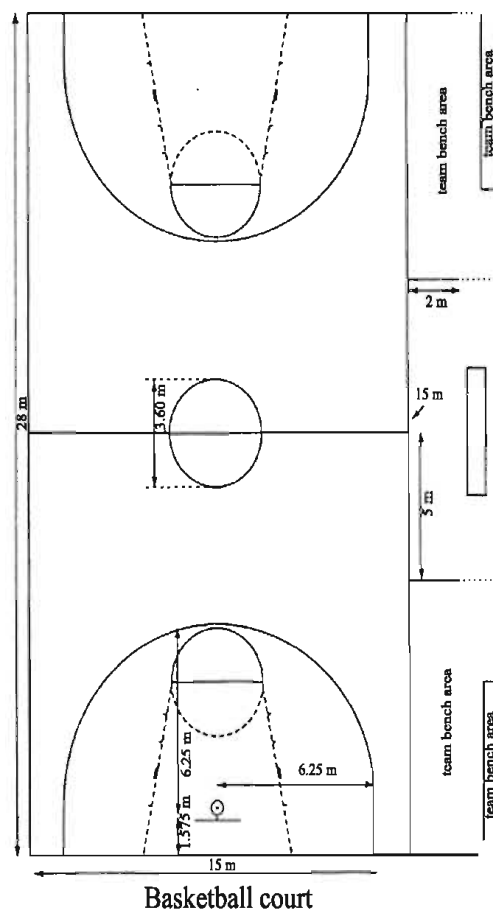

4. Ring: The height of the ring is 3.05 meters and 15 cm away from the board. There will be net with the ring.

5. Ball: Ball will be rounding (spherical) shaped. There will be 8 panel on ball and orange in colour. Ball will rough so that will be easy to grip.

6. Playing time: The total time is 40 minutes, which is divided into four quarters of 10 minutes each. There is an interval of two minutes in between the first and the second quarters, the third and the fourth quarters. There is a 15-minute interval in the game.

7. Point: If a team scores from outside the 6.25-meter marked line, they will get 3 points and if from inside 6.25-meter line, they will get 2 points.

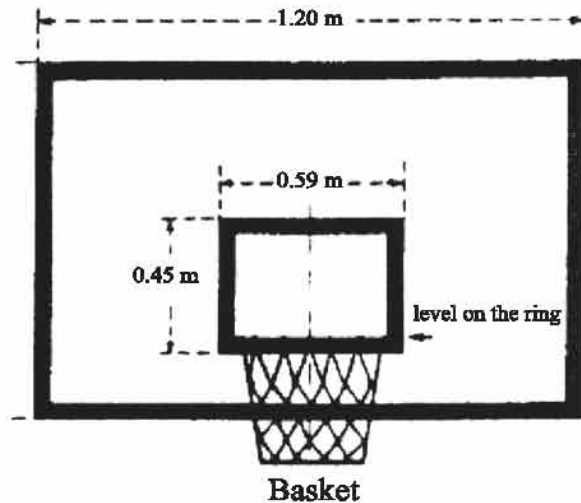

8. Start of game: Through toss court will be selected. Two players will stand inside the centre circle. The game will start by throwing the ball in the air.

9. 3 seconds rules: If a team in an attacking position any player of that team cannot stay inside the restricted area over 3 seconds.

10. 5 Seconds rules

a) A team has to take the throw within 5 seconds after the referee's whistle.

b) A player cannot hold the ball more than 5 seconds.

c) A player has to dribble or pass the ball within in 5 seconds after catching it.

11. 8 Seconds rule: A team can control a ball 8 seconds in their own court. The team has to take the ball to the opponent court within 8 seconds.

12. 24 Seconds rule: All the players of a team can keep control on a ball up to 24 seconds.

13. Violation: Violation of any rules such as not to raise the hand at the time of personal fouls to break 3, 5, 8 seconds rules.

14. Technical fouls: A player is not respectful to officials and intentionally disobeys rules and show unsportsman like conduct.

15. Personal fouls: If a player does an illegal physical contact with opponent during the play or when a player is dead, it is called a personal foul.

16. Intentional fouls: A foul committed by a player intentionally with the opponent is known as an intentional foul.

17. Double foul: The foul committed by two players of two teams against each other at the same time is known as double foul.

18. Five foul: If a player commits five fouls technical or personal within 40-minutes game, he will have to leave the court.

19. Seven foul: Team foul of a team in each half is seven or more, that foul may be personal or technical. For each foul opponent will get 2 (two) free throw. If duration game is 4x10 minutes then four personal or technical foul in each quarter, after that for every foul opponent will get 2 (two) free throw.

Technique: A good basketball player requires endurance, agility, speed, and jumping ability. Simultaneously they require expertise on the following basic skills.

1. Stance: Stand with both feet apart from each other keeping a comfortable distance between them. Knee little flex, upper limb little incline forward, both hands near to chest a bit above the chest height, palm facing opponent, and elbow also down ward.

2. Catch the ball: A player has to catch the ball in such a way that the ball should be under his control. Fingers are spread, flex and a bit round shaped, during catching the ball. Thumbs usually control the ball. Catching the ball with palm is not the correct technique.

3. Pass: In basketball, during passing the ball, the wrist and the elbow are more active than other parts of the body. While giving a pass, one foot is ahead and the other leg a bit back. There are many types of pass in basketball. Some of them are given below.

a. Chest pass: Pass fast at chest height.

b. Pass below the head height: This type of pass is used when players are close and is given very fast.

c. Hook pass: Away from the opponent, this type of pass is given over the opponent's head. Generally this pass is given using one hand.

d. Bounce pass: A pass is given to a team-mate giving a drop or bounce on ground.

4. Dribbling: Dribbling is used to change the place and to go forward. Generally, dribbling is done by one hand or by turns by the left or the right hand.

5. Pivot: When a player fixes his one leg and moves the other leg in any direction as many times as he wishes it is known as pivot.

6. Shooting: Throwing a ball to score a basket is known as shooting. Shootings are of two types (i) directly into ring. (ii) With help of board.

a. Set shoot: Shooting while standing without movement is known as set shoot. A set shoot can be taken by one hand or both hands. While shooting by one hand, the shoot taking hand will be behind the ball and the other hand will be used to support the ball so the ball can travel to the basket accurately. Again when shooting with two hands, both hands are behind the ball.

b. Layup shot: Normally a lay up shot is taken to score from a short distance. A player moves forward by dribbling and he jumps up on his foot from the ground and tries to take a lay up shot direct to the basket or with the help of back board.

Activity-1: Show the technique to grip a ball.

Activity-2: Show or demonstrate a chest pass with a partner.

Activity-3: Practice the technique of a lay-up shot.

Lesson-7: Hockey

Though there is no concrete evidence about its origin, it is believed that it descended from the earliest civilization and it is one of the ancient games. As per knowledge goes, in 2000B.C there was a game like hockey in Persia. Afterwards it was introduced in Greece and from Greece it went to Rome. About 2500 years back historians observed a similar game like today's hockey in East Greece. Afterwards the people of France started the game named hocket. Hocket is a French word which means a shepherd's stick. After many years the English people started the game named as Hoque after learning it from the French. According to the English pronunciation this game spread all over the world as Hockey.

1. **Team:** A Hockey team consists of 16 players, 11 players play the game while other 5 players are additional or substitute players.
2. **Attack:** During the play the team that tries to score a goal is called the attacking team.
3. **Defensive team:** During the play a team engaged in not to concede a goal is known as defensive team.

4. **Centre pass:** Putting the ball at the centre of the field, pushing or hitting in any direction is called centre pass. Game begins with this pass.

5. **Playing the ball:** Playing the ball means to stop, go forward, change the direction or speed up the ball.

6. **Playing distance:** A distance from where a player can reach and can play the ball.

7. **Tackle:** To take control of the ball from the opponent. The techniques by which a player takes control of the ball from opponents are known as tackle.

8. **To hit a ball into goal:** An attacking player tries to hit the ball towards goal post from inside the circle.

9. **Fouls:** A player does not follow the rules or disobeys the rules for which an umpire can punish the player.

10. **Stroke:** The method of playing the ball with the stick to go forward and hitting the ball is called stroke.

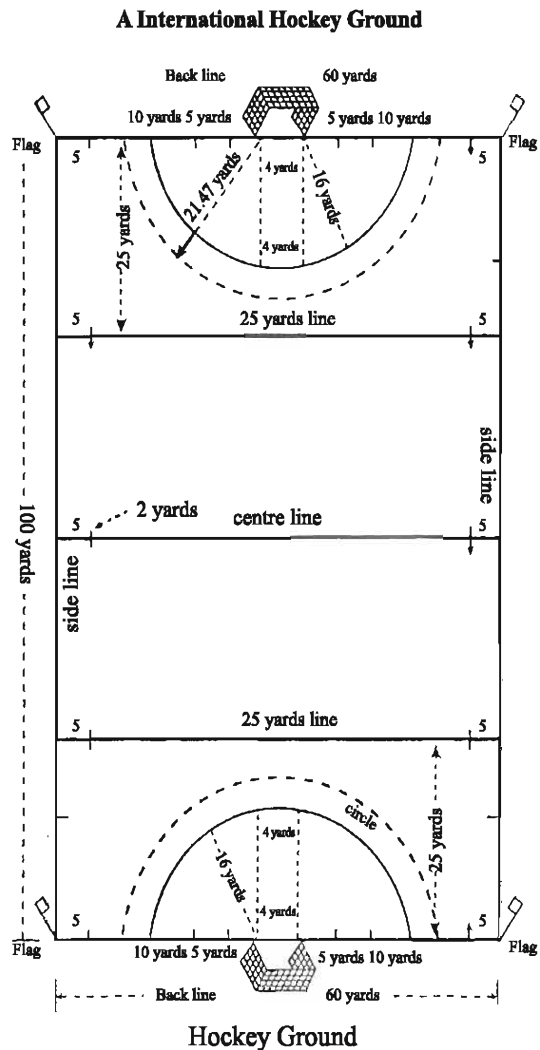

11. Penalty stroke: Try to score a goal from the penalty spot by the push or scoop is called the penalty stroke.

12. Dangerous play: A technique to play the ball which is dangerous for the opponent.

13. Misconduct: Misconduct is as follows-waste time, intentionally commits a foul, during play misbehave with others, disobey the captain.

Playing area: Hockey field is rectangular, length-100 yards, width 60 yards. The length line is called sideline, width line is called end line and in between two goal posts is known as goal line. The width of the line is 3 inches.

Shooting circle: A half circle of radius of 16 yards on both sides of the post. Middle 4 yards parallel to the goal post is known as shooting circle. 5 meters away from the shooting circle another circle will be drawn, with dotted line. A line is used to stand the player.

Midline and 25-yards line: A line joining the two midpoints of length line is called midline. A line behind the midline is known as 25-yards line.

Goal Post: The distance between the inner side of two posts will be 4 yards, and the height of the lower side of the cross bar from the floor will be 7 feet. The colour of the goal post and the crossbar will be white.

Ball: The ball will be made of hard material. The colour of the ball will be white. A different colour of ball may be used with the agreement of both teams.

Hockey stick: The stick will be straight and the head will be curved. The left side of the stick will be flat and the right side will be smooth and round shaped. This curve of the stick will not be more than 4 inches. A 2 inches diameter ring passing through the head of the stick is considered to be a correct stick.

Goal keeper: The colour of the dress of the goal keeper will be different from that of the other players. To protect the upper part of the goal keeper, he will use a protector. He can use the leg guard, kicker and hand protector.

Duration of play: 35 minutes for each half with 5 to 10 minutes interval.

Penalty corner: If any defensive players-

- (a) Intentionally foul is committed within the circle
- (b) To save definite goal, an unintentionally foul is occurred outside the circle
- (c) Goal keeper is broken rules again and again. If occurred above this foul opponent- team use be awarded penalty corner. Penalty corner is taken 7 yards spot from the goal line.

Skills

Hold a stick: A right hand player hold the top of the stick with left hand, and will hold the middle of the stick with the right hand. The right leg will be ahead and left leg will be a bit back. A player will move the stick left and right with left hand, while the right hand will support the stick.

Stop the ball: To stop the ball the head of the stick will be along the line of the ball and the ball will be stopped by the flat part of stick. One leg will be ahead and the other back.

Dribbling the ball: The ball will be in front of a player who will move the ball forward with the help of the stick by moving left and right. A player can dribble the ball by pushing the ball in between the ball will be played with the flat part of the stick.

Hit: A player stands keeping both the legs parallel and 1½ to 2 feet away from the ball. Lifting the stick up to the shoulder level he will hit the middle part of the ball. Hitting hard the ball is called hit.

Push: Pushing the ball with the flat part of the stick without making any sound means the ball will be in contact with the stick.

Flick: When a ball is pushed it is stable or in motion and if the ball rises up to the knee height it is called flick.

Scoop: When a player pushes the lower part of a stable ball to travel in the air above head height it is called scoop.



Scoop

Activity-1: Show the technique of taking penalty stroke.

Activity-2: Demonstrate the technique of scoop and show to the classmate.

Activity-3: Explain the technique to hold a hockey stick.

Lesson- 8: Handball

Handball game has its origin in Germany. In the German lyrics dating back to 12th-13th centuries, mention had been found of something like CATCH BALL. In 1917 Max Husser of Berlin a sports teacher for women invented the hand ball game for women. The Hand Ball Association of Bangladesh came into being in the year 1983 and later on in 1985 it turned into a federation.

- 1. The playing area of Hand ball:** The field of Hand ball game is 40 m long and 20 m wide. The marks/signposts are 5 cm thick. The line inside the goal post is 8 cm. The sign post on length is called sideline while the sign post on the width is called end line.
- 2. Goal post:** The height of the goal post from the floor to lower part of the crossbar is 2 meters and the length is 3 meters.
- 3. Goal area:** A line is to be drawn with a radius of 6 m which would be equi-distant from both the goal posts. A 3-meter straight line will be drawn parallel to goal the post whose dots will be 15 cm in length.
- 4. Free throw line:** Similar to the goal area line two quarter circles of 9-meters radius of both goal posts, and from goal line to the front of goal post and the rest 3-meters will be parallel to the goal line a dotted half circle known as free throw line.
- 5. Penalty line:** A 15 cm line 7 meter away from goal line and parallel to the goal line is know a penalty throw line.
- 6. 4 meter line:** A 15 cm line at 4 meter away from goal line and parallel to the goal line is called 4 meter line.
- 7. Duration of play:** Duration of play for boys and girls of 16 years and above is $30+10(\text{break})+30=70$ minutes and for 12-16 years boys and girls duration of play is $25+10(\text{break})+25=60$ minutes.

8. Officials: There are four officials, Two referees, one time keeper and one score taker.

9. Ball: The ball must be produced by leather or some synthetic material. It must be spherical. The surface must not be shiny or slippery.

10. The players: A team consists of 12 players (10 court players + 2 goalkeepers). No more than 7 players (6 court players + 1 goal keeper) on the court. The remaining players are substitutes.

11. Restrictions for goal keeper

- a) Play dangerously
- b) Leave the goal area with ball
- c) Taking the ball in to the goal is when it is outside the goal area.
- d) Touch or cross the goal keeper's border line (4-meter line) before the ball has left the thrower's hand when a penalty throw is being taken.
- e) Intentionally play the ball over his own outer goal line once he has got the ball under control.

12. A player is not permitted

- a. Cannot hold the ball more than 3 seconds
- b. Cannot move more than 3 steps without dribbling.
- c. Cannot pull, push or hit the opponent while catching the ball
- d. Cannot touch the ball by below the knee

13. Throw-off: The game begins with throw off and after scoring a goal, the play also starts with throw-off.

14. A free throw is awarded in the case of

- a. Incorrect substitution
- b. Illegal entry inside the field
- c. Infringements by the goal keepers
- d. Infringements by court players in the goal area

- e. Deliberately playing the ball across the outer goal line or side line
- f. Fouls concerning the approach to the opponent
- g. Infringements in connection with throw-off and throw in
- h. Assault in and of the field

15. Penalty throws

A penalty throw shall be awarded

- a. When a clear chance of scoring is spoiled by an infringement in any part of the court .
- b. The goal keeper holds the ball in the field and enters into the goal area.
- c. When a court player intentionally plays the ball to his own goal-keep in the goal area.
- d. If spoiled a clear chance of scoring by an illegal whistle.

Skills: The basic skills of handball are as follows.

1. Catching the ball.
2. Passing the ball.
3. Shots on goal.
4. Obstruction.

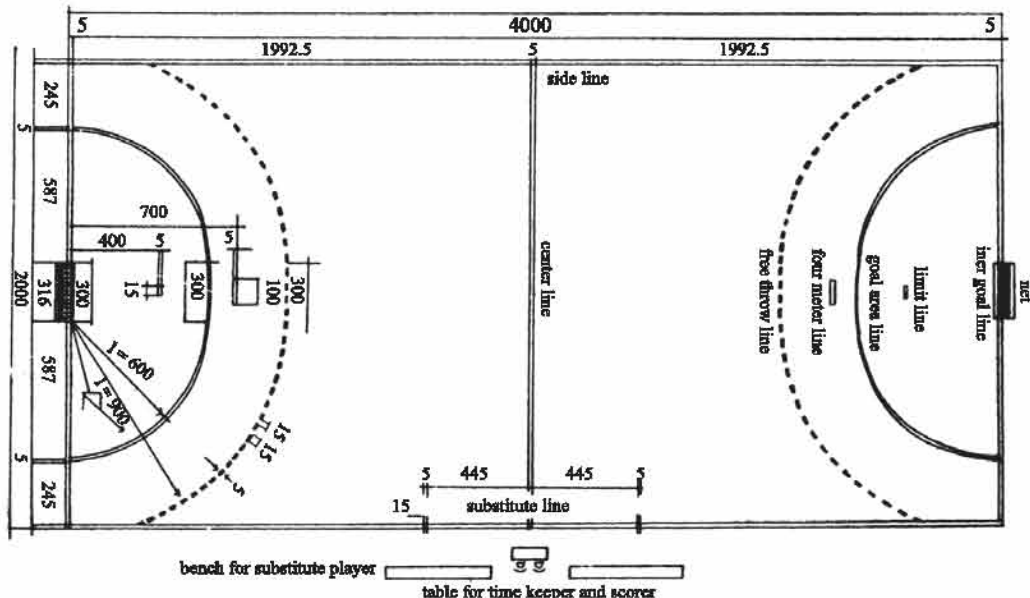

Handball field

1. Catching the ball: At the time of catching a ball, a player spread out his fingers, keep his eyes on the ball and bending his elbow, pull the ball towards himself. The ball may be hold to consider speed and position of the ball as- line with the shoulder, below the waist, standing and jumping above the head. Rolling ball catches front of sideways.

2. Passing the ball: Passing the ball is an important technique in handball. There are many types of passing techniques in hand ball.

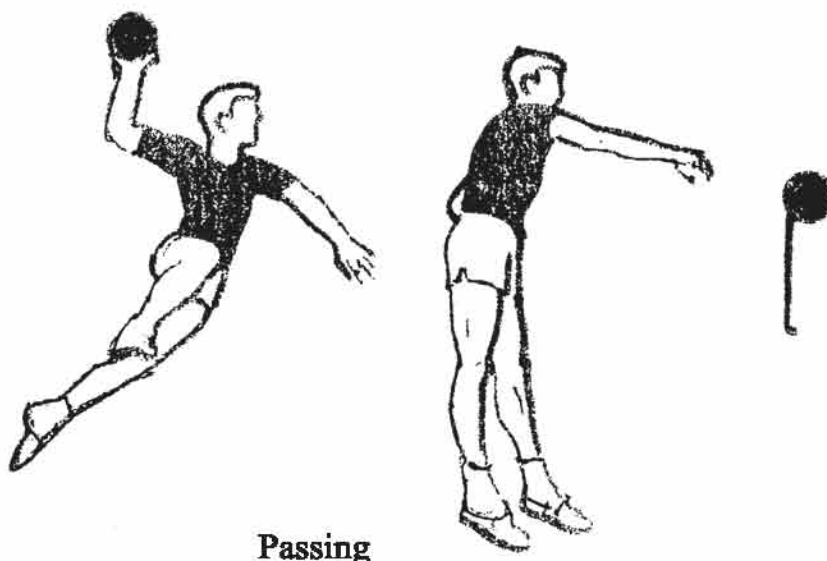

a. Shoulder level pass. b. Wrist pass. c. Below the waist pass d. Above the head etc.

3. Shots on goal: Scoring a goal in hand ball is very important so that the skills of throwing the ball on goal for a score have to be learned. The player should know the technique of how to throw a ball on goal. There are different types of technique such as throw directly on goal, jump and throw, bounce on goal area to score a goal etc.

4. Obstruction: When the opponent player is forwarding with the ball to score a goal, he should be prevented in such a way that he is unable to pass the ball to his mate or throw the ball to the goal. To do that a player alone or two or three players will build a wall by raising their hand or with body to obstruct opponent.



Obstruction

Activity-1: Write on a poster paper the causes of awarding a free throw and present it in the class.

Activity-2: Demonstrate the technique of catching the ball.

Activity-3: Explain the position of body while throw on goal.

Exercise

Multiple choice questions

- Which one is the technique of playing handball?
 - hold the ball
 - hold the stick
 - shooting
 - hold the waist
- From which one of the following is not declared goal by the referee in spite of the ball being entered straight into the net?
 - corner kick
 - goal kick
 - direct free kick
 - indirect free kick

3. In the game of basketball the things we notice, are -

- (i) can stay till 3 seconds in the restricted area
- (ii) if there is a score from the free throw of the ball it will get 1 point
- (iii) the player will have breath, rapidity, speed and the power of jumping

Which one in the following is correct?

- a. i & ii
- b. i & iii
- c. ii & iii
- d. i, ii & iii

Observe the stem and answer the questions. 4 & 5.

A
100×60 yards

B
40×20 meters

C
115×75 yards

4. Which playground is indicated by A marked picture?

- a. football
- b. handball
- c. hockey
- d. basketball

5. There is similarity of the playing in the B and C playgrounds as mentioned in the stem.

- i. offside
- ii. dribbling
- iii. passing

Which one in the following is correct?

- a. i & ii
- b. i & iii
- c. ii & iii
- d. i, ii & iii

Read the stem and answer questions 6 & 7.

Arif is a goal keeper. He occasionally plays as a field player but due to his committing foul the referee gives free throw against him.

6. Of which game is Arif the player?

- a. football
- b. handball
- c. basketball
- d. hockey

7. The referee can give free throw against Arif -

- (i) if he enters the goal boundary by taking the ball from the ground
- (ii) if he runs more than three steps by holding the ball
- (iii) if he moves by taking the ball from the ground

Which one in the following is correct?

- a. i & ii
- b. i & iii
- c. ii & iii
- d. i, ii & iii

Creative Questions

1. While playing cricket in the field, the bowler bowls against the batsman Monir. As the ball hits the leg of the batsman, several players including the bowler prayed for out with one voice. But the umpire shaking his head instructs to continue the play. In the 10th over when the new batsman Shakil faces his first ball, the ball hits the stamper and the bell falls down but the umpire expanding his right hand shows the sign. It frustrates the fielders.

- a. What is called by-run?
- b. To which technique does delivery belong? Explain.
- c. Explain the reason of praying for out with one voice as mentioned in the stem.
- d. Analyse the logic of the umpire's 2nd decision.

2. In the inter-class T-20 cricket tournament the students of class nine winning the toss were elected to bat first. As the students of class ten missed some catches and did not save boundaries, the opening pair built a 100-runs partnership and scored a big total of 180 run for 2 wickets. Chasing the target of 181 runs, the umpire declared the opening batsman out in the 1st over as the ball hit his leg directly. The students of class nine were spontaneous and lively. They saved several certain boundaries of the opponent and did not miss any catch. As a result the students of class ten did not exceed the target.

- a. How many panels will there be over the basketball?
- b. What is meant by lonaball? Explain.
- c. What is the nature of out of the opening batsman? Explain.
- d. What reason do you think works for the success of the students of class nine? Give logic in favour of your answer.

Chapter Nine

Athletics and Swimming

Athletics and swimming are the best way for the exhibition or display of personal sportive feats and skills. Athletics includes but is not limited to events such as running or racing, jumping and throwing etc. In the primitive age, people utilized these feat and skill for survival. At the advent of human evolution and with the advancement of human adaptation to natural calamities, these two techniques were later on considered to be the best personal feat and skill for sports and games. In ancient times, there was hardly any technique or rule for swimming. But at a later stage, swimming was taken as a unique medium or technique for building sound physique and it also later on turned out to be a wonderful instrument for amusement. Athletics and swimming positively impact on building a sound physique, achieving personal sportive feats and skills and being obedient to some given norms and laws and these consequently lead the students towards becoming ideal citizens of the country.



Running

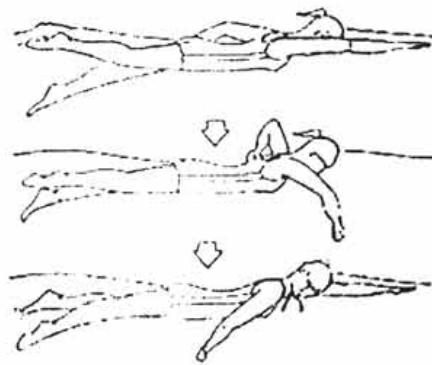

Swimming

In this chapter, we will be able to—

- explain the various rules of athletics;
- interpret the various techniques of the tracks and field events of athletics;
- describe the qualities and qualifications of the athletes relating to various events;
- describe the qualifications and features of swimmers relating to different events;

- explain the rules and regulations of various events of swimming;
- brief the strategies of various events of swimming;
- exercise and practice various events according to the governing laws of athletics;
- practice swimming through abiding the laws, rules and regulations of swimming.

Lesson-1: The Guiding Rules for the Events of Athletics (Track & Field)

Out of the numerous games throughout the world, running or racing, jumping and throwing are the most primary. A human child after its birth undergoes various stages such as running, jumping and throwing during its growing-up phases. In ancient time, people had to run and jump for survival such as for hunting or safe guarding from the attack of animals or saving life from other hazards and dangers. People at that time used throwing or pelting technique to defeat enemies or for hunting animals. These three techniques were thus utilized essentially for their livelihood and survival. With the passage of time, running, jumping and throwing changed from the survival technique to personal skill development and amusement instruments along with the advancement of civilization.

The events of Athletics are divided into two parts as shown below in the figure:

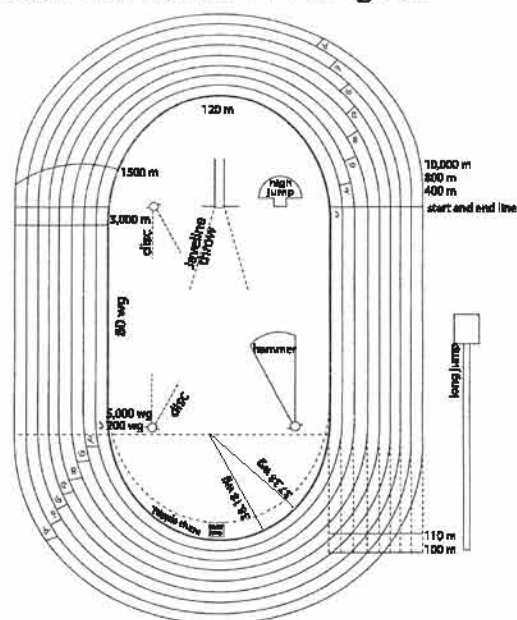
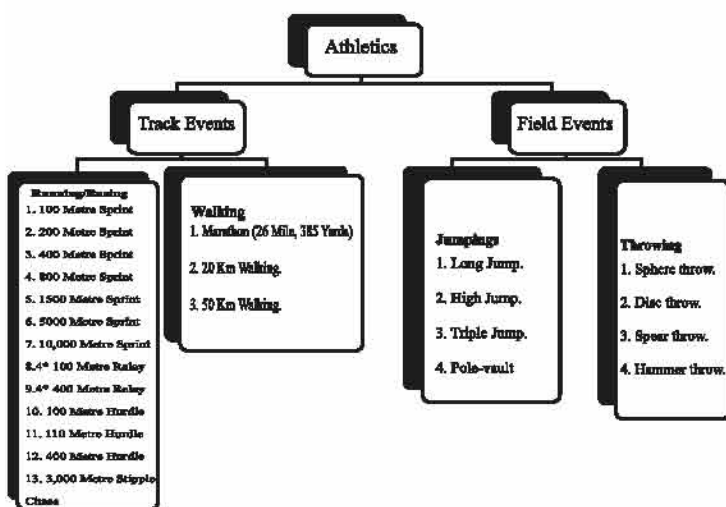

Athletic track

N.B.- 5,000-meter run, 10,000 meter run, 4×400 meters relay race, Hurdle Run, 3000 meter Stipple Chase, Walking events and Hammer throw are not usually held at Inter School and Madrasah Sports Competitions.

General Principles of Running/Racing Competition

1. A 400-meter Track is the allowable track for the running or racing competition.
2. During running or racing competition, the athletes would run keeping the 1st Lane in the left.
3. Lane cannot be changed during sprint i.e. 100 meter, 200 meter, 400 meter, hurdle run, 100×4 meter run and every individual/performer would have to run in the specified lane.
4. During relay run of 800 meters, 1500 meters and 4×400, meters lane can be changed. After going to certain distance, how lane can be changed needs to be well understood before the kicking off the running or racing competition.
5. For sprint, starting block needs to be used but in other running or racing, starting block is not mandatory.
6. During the run or race, one should put on the finishing stand.
7. Finishing ribbon must be in touch with the Torso first.
8. The starting and ending point of the run or race must be marked with white color.
9. All the runs do not have the same starting point but always end at the same place or point.
10. Runners must start all runs at the sound of the fire.
11. During sprint run, the starter must use three instructions
 - a. On Your Mark.
 - b. Set.
 - c. Fire or firing of pistol.

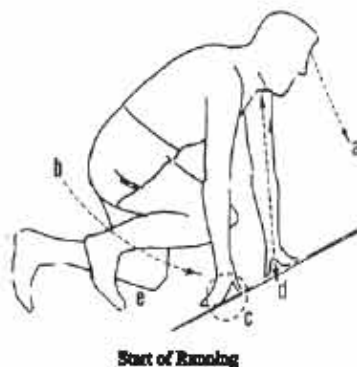

12. If once false start takes place, the incumbent or the performer will be disallowed or discarded.
13. During Marathon, Set need not be used. Only one needs to run or race after the utterance of the word “On Your Mark” and hearing the sound of the fire.

The Technique of Sprint Run or Race: The run or race with the highest velocity and speed is called Sprint. Any run or race from 100 to 400 meter falls within the purview of Sprint. Start plays a vital role in case of Sprint Run. There is a proverb, “A good beginning is half the battle”. This purely fits in the case of Sprint Run. A good start gives actually additional advantage for Sprint Runners.

The start of the Sprint Run can be made in the following three ways:

- 1) Bunch Start
- 2) Medium Start
- 3) Elongated Start

1. Bunch Start: The front leg is kept two steps behind from the starting point and the tip of the hinder leg will be aligned with the hill of the front leg.

2. Medium Start: The front leg will be two steps behind the starting point and the toe of the hinder leg and the strength of the front leg will be aligned.

3. Elongated Start: The front leg will be three steps behind the starting point and the toe of the hinder leg and heel of the front leg will be aligned.

Sprint Run has four phases. These are:

- | | |
|------------------|------------------|
| 1. On Your Mark. | 2. Set. |
| 3. Drive. | 4. Acceleration. |

1. On Your Mark: As soon as the “On your Mark” is pronounced, the athlete would set their legs 20-25 centimeters behind from the starting point and the fingers of two hands on the starting point upon the ground. If legs are positioned on starting block, that need to be placed earlier or immediately on the specific spot. The vision will be straight forward. The runner would have to sit folding the knees and pressing on the palm of hands.

2. Position before the moment the Run starts: As soon as the starter utters SET, the hinder leg needs to be straightened and bent forward. The hip will rise upward. The whole mass of the body will hinge upon the hands. One needs to be stable and silent while one can hear the sound of the fire within 2-3 seconds.

3. Drive: As soon as one hears the sound of the fire, one need not stand rather needs to bend forward.

4. Acceleration: Soon after this, one has to run accelerating the velocity and speed. These four positions are displayed through the following pictures:

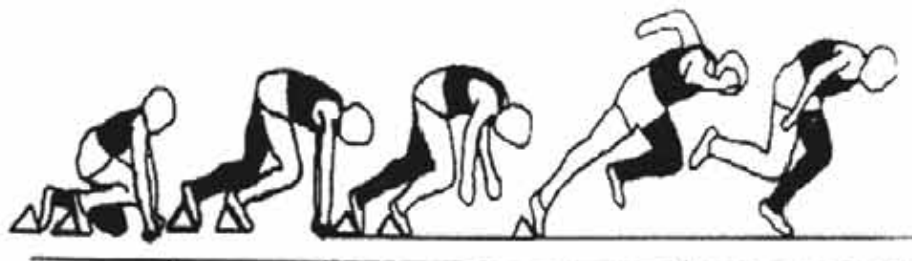

Various phases of Starting.

Start Standing: In case of medium and long distance run, it is needed to start from the standing position. As soon as the starter utters "On Your Mark", one needs to come to the starting point. Then one needs to start running after hearing the sound of the fire.

Ending of the Running: All runs will end at the same point. The run will be accounted to have been finished when the head and leg will merge on the ending point.

Relay Race: When four competitors or performers run smoothly parallel from a certain distance, this is called Relay Run.

The following rules need to be followed in Relay Run

1. One needs to run with Baton.
2. Baton needs to be changed at the point marked for Baton exchange.
3. The space for Baton exchange is 20 meter.
4. The length of Baton is 28-30 centimeter, radius 38 mm and weight 50 gms.
5. The Baton is made of wood, metal or similar object.
6. After exchange of Baton, the players would have to be in their respective places until other competitors cross him or her.

Technique of Baton Exchange: The most important thing to remember during Baton exchange is that the velocity or speed does not decrease at any cost. So the technique needs to be revised time and again. The technique of Baton exchange is of two types- 1. To exchange by seeing the Baton, 2. To exchange without seeing the Baton.

1. Exchange by seeing: When one exchanges Baton looking behind, this exchange is called Exchange by seeing.

2. Exchange without seeing: When Baton is exchanged through speedy run from behind and without looking back, this is called Exchange without seeing.

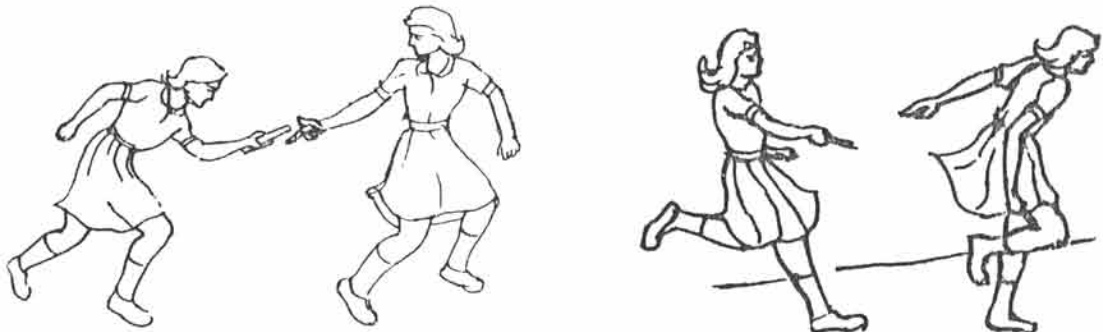

Fig. (1) Exchange by seeing

Baton Exchange

Fig. (2) Exchange without seeing

The Rules of Baton Passing: This technique is of two types. These are-1. Upward Pass, 2. Downward Pass.

Upward Pass: When the passing of Baton/stick/staff takes place with the head of Baton/Stick/Staff upward, this is called Upward Pass.

Downward Pass: When the passing of Baton/stick/staff takes place with the head of Baton/Stick/Staff downward, this pass is called to be Downward Pass.

Whether the baton is passed upward or downward, the efficiency and efficacy depends on a sound practice and exercise of the players or performers or the competitors.

Activity-1: Ask the player to show how the start for Sprint takes place by going physically to the field.

Activity-2: Show the techniques of touching the ending point of run/race/sprint in group.

Activity-3: Explain the techniques of exchange of Baton by seeing or without seeing and demonstrate in the field.

Lesson-2: Division of Jump

Division are as follows: a. Long Jump, b. High Jump, c. Hop Step and Jump, d. Pole Vault.

The general Principles of Long Jump

1. Approach run: One has to run through the runway.
2. The length of runway needs to be at least 40 meters, Width 1.22-1.25 meters, and both sides should be marked with white color.
3. The length of Takeoff board should be 1.21-1.22 meter, width 19.8 cm-20.2 mm and height 100 cm.
4. The takeoff board will be at a distance of 1-3 meter from the jump pit.
5. The measurement of the Jump pit would be 10 meters, width 2.75-3 meters.
6. The color of Takeoff board would be white.
7. The jump pit will be filled in with sand but will not rise above takeoff board level.
8. The measurement needs to be taken from and on where the maximum part of the body would touch the sand.
9. A competitor/player would be considered to have been disqualified if he or she -
 - a. Fails to jump within 60 seconds from the name call.
 - b. Jumps out of the Takeoff board.
 - c. Touches the ground out of the landing area before landing.
 - d. Walks back after completing the jump.
 - e. Performs takeoff with two legs.
 - f. Touches the ground in front of the takeoff board.

The Technique of Long Jump: Those who are sprinters usually fare well in long jumps. To be an expert long jumper, he or she needs to acquire strength, velocity and speed which usually a sprinter possesses. The techniques of long jump falls under four categories: 1. Approach Run, 2. Takeoff (To rise up giving pressure on ground), 3. Flight (to float on air), 4. Landing (To descend on the ground).

1. Approach Run: For the purpose of jumping, when one comes running with heavy speed from a distance of 50 to 80 feet, this run is called Approach Run.

The last approaches need to be very drastic and speedy. A sign is posted at a distance of 15-25 feet from the takeoff board so that legs are stamped accurately. This sign is called check mark. If the legs touch properly this check mark, it can then be reasonably presumed that legs will also touch the takeoff board. An athlete has to practise again and again to make sure that legs touch the takeoff board properly.

2. Takeoff: In a long jump, there is an arrangement of a takeoff board to enable the jumpers to rise high leaving the ground. This board is 4 feet long, 8 inches wide. The surface is colored white. When legs float in the air from this board, it is called takeoff. One who excels in takeoff, will jump longer distance.

3. Flight: The time duration between the rise of legs from the takeoff board till they ground is called Flight or floating in the air. To walk, fold knees, heavy jerking of legs and Hitch Kick are the methods for floating in the air. One whose movement in the air is excellent would cover longer distance.

4. Landing: While landing or descending on the ground, one needs to keep the legs straight and keep himself or herself at full length forward before touching the ground so that one can cover longer distance. The heels would first touch the sand of the landing pit and soon after that, folding two knees, the whole mass of the body would be passed to the tip of legs and the performer or competitor would fall sliding forward.

Activity -1: Ask the learners to show if he or she can perform the takeoff of the long jump properly.

Activity-2: Ask them to demonstrate the right position of legs during landing is ensured.

Lesson-3 : High Jump

Rules of High Jump

1. The competitors need to be informed about the height of jump before starting the high jump and announced how much the height will be increased in every round.
2. After the rounds being over, the height needs to be raised at least 2 cm.
3. Length of the runway should be at least 15 meters.
4. A competitor for his or her convenience can use more than one mark or signpost to adjust or fix his or her Run up and Takeoff.

5. The distance between two poles should be 3.64 meters to 4 meters.
6. The crossbar may be made up of wood or metal or similar objects.
7. The measurement for landing area for high jump is 5 x 4 meters.
8. A competitor loses his or her chance when he or she -
 - a) Fails to jump within 60 seconds from the roll call.
 - b) Crosses the line of the crossbar while jumping.
 - c) Performs takeoff with two legs.
 - d) Falls on the crossbar while jumping.

Techniques of High Jump: A competitor has to undergo four stages in high jump, whatever be the technique of high jump. These techniques are- 1. Approach Run, 2. Takeoff, 3. Crossing the crossbar 4. Landing.

1. Approach by running is called Approach Run.
2. To get up or fly, keeping the weight on leg after running is called Takeoff.
3. The crossbar has to be crossed by any method for high jump.
4. Falling on the ground after crossing the crossbar is called Landing.

There are three methods of High Jump-

1. Western Roll, 2. Belly Roll, 3. Fosbury Flop.

1. Western Roll: The special feature of this method is that the landing will take place with the same leg which has been used for the takeoff. If the takeoff is performed by the left leg, then after crossing the crossbar, landing will also be performed with and on the left leg.

- a. Jump is usually initiated after seven steps forward but if the height is less, then five steps are adequate.
- b. For the purpose of jumping, one has to stand at 45° to 60° angles with the crossbar at the time of running.
- c. At the time of mounting or taking off from the ground, one has to notice that the last three steps would be speedy and comparatively long.
- d. The hinder leg needs to be thrown very forcibly upward while the leg upon which the competitor will leave the ground needs to bear the whole weight of the body and the same leg would roll or slide from the heel to the tip of that leg.

- e. The leg used for leaving the ground would later be folded at the knee for rising upward.
- f. On the crossbar, the whole body needs to be whirled or bent and the shoulder needs to be kept vertically aligned with the obstacle ahead to cross the crossbar.
- g. The leg upon which landing will be performed should be used along with two hands at the time of landing.

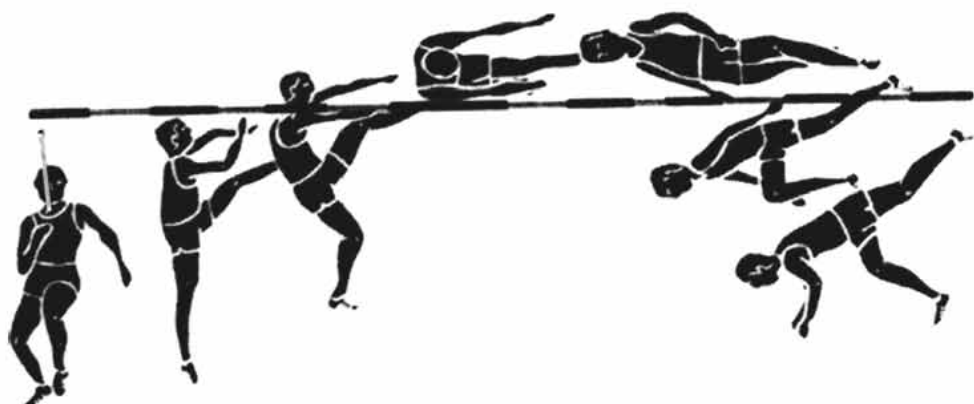

Western Roll

2. **Belly Roll:** The feature of this method is that the competitor will use one leg for the takeoff while the opposite leg and two hands will be used for landing. If foam is used for landing, according to convenience, landing can be done on the back as well. In this method, one should remember-
 - a) The running angle should be 25° to 40° angles with the crossbar.
 - b) During takeoff, the last steps would be faster and longer. But after leaving the ground, the opposite leg and hand of the concerned side need to be first raised above the crossbar.
 - c) While nearing the crossbar, the upper part of the body needs to be bent or inclined downward. It helps keep the belly part come closer to the crossbar.
 - d) The upper part of the body (from shoulder to hip) of the corresponding leg and hand which is lowering down needs to be lowered further while pushing the hand forward and inside the body. Then simultaneously the competitor would let the body slide during landing.

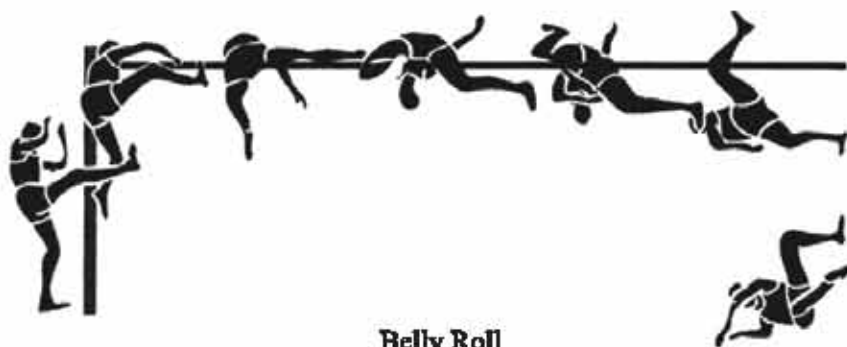

Belly Roll

3. Fosbury Flop: In 1968, Mr. Dick Fosbury from America won gold medal in the Mexico Olympic using a new method in High Jump. According to his name, this high jump is named Fosbury Flop. This is treated now as a universal method. But one should keep in mind that jumping in this method is not possible without foamed mat.

- a. In this method, the competitor has to stand at 90° angles with the crossbar and he or she has to come closer to the crossbar in a half circular motion.
- b. The middle of the body is jolted and bent while the takeoff of the leg is placed at the epicenter of the body. After that, one has to rise upward with haste and force. At the same time, the other leg is hung and raised towards the right shoulder-line. As a result, the back will be inclined towards the crossbar.
- c. When the body will leave the ground and fling upward, the hands need to be immediately placed parallel with the body and the head; the middle part of the body and the lower part of the hip would have to be crossed upon the crossbar. The hands and legs would be facing upward while the performer would land on the back.

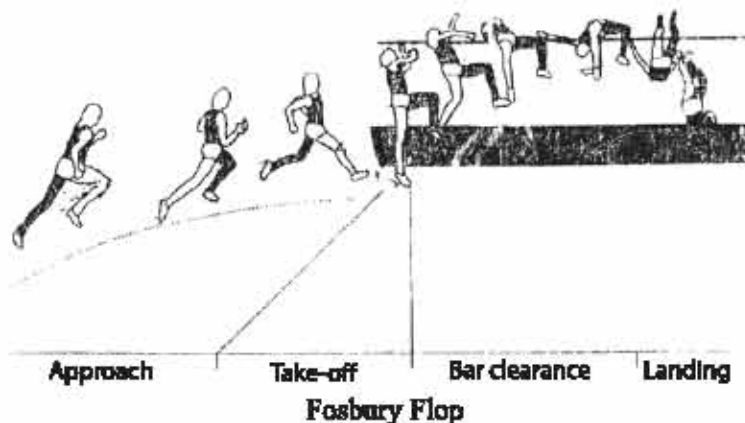

The Tie of Athletics: Tie means equality. When the two competing players have the same result, it is called Tie. Tie is of two types. 1. Tie of height, 2. Tie of distance.

1. Tie of Height: When tie occurs in Pole vault and high jump, it is called the Tie of the height, because tie happens in terms of height.

2. Tie of Distance: when tie occurs among the competitors of Long jump, Hop Step jump, Disc throw, sphere throw, spear throw, Hammer throw events, these are called to be the Tie of distance. Only Tie has to be postponed for the 1st position but for the 2nd and 3rd position, the result is announced simultaneously.

1. If Tie occurs in Height, the rules for breaking the Tie are

- a) The height for which the Tie has occurred, the person who has achieved this score with less effort will be the first winner.
- b) If Tie can't be broken according to the rule mentioned above, the competitor whose cross is less from the first to last will be the first winner.
- c) If the Tie still does not break, the jump needs to restart either increasing or decreasing the height. One who can cross successfully would be the winner. Here the competitors would have only one chance for jumping.

Rule for tie Breaking in case of Distance:

- (a) Out of total throw of jump, the 2nd highest distance needs to be noticed.
- (b) If tie still does not break according to this rule, then the 3rd highest one is to be examined. (In this way, it would gradually advance).

Activity-1: Show/train the jumping method whichever you like.

Activity-2: Describe the method of Belly Roll.

Lesson-4 : Triple Jump or Hop Step Jump and Pole Vault

1. Triple Jump or Hop Step: The jump that combines Hop Step and Jump is called Triple Jump. The leg used for takeoff is also used for first hop and the opposite leg is used for hop and then jump in this method. In this event, all the three kinds of jump carry equal importance. If ratio is properly calculated in these three types of jump, one can cover longer distance through practice and

exercise. Usually, 6:5:6 ratio is very advantageous for the new athletes. If first hop is 6', then step will be 5' and last jump will be 6'. If the left leg is used for takeoff, then the same leg needs to be used for hop and then the right leg should be used for step and then jump should be performed.

Approach Run: In this case, one has to rush like that of the long jump. The speed of running or racing is controlled in such a way that the speed reaches the highest at the time of leaving the ground.

Takeoff: The takeoff of long jump and triple is not the same. In case of triple jump, efforts are made to ensure how to keep the speed forward intact or uniform. The first hop should not be taken at too high a level. If the natural hop gradually rises, the jump attains perfection. The height of step should be higher than that of hop, which should be higher than the previous both feats.

To Float in the Air and above the Ground: In this case, legs are moved and oscillated the same way that of the long jump, so that longer distance can be covered.

Landing: The technique for landing is similar to that of the long jump.

Guiding Rules:

1. If more than 8 competitors take part, in that case, after three jumps, 8 competitors need to be selected and those 8 people will again jump for three times. In these 6 jumps, whoever secures the highest distance will be the winner.
2. While jumping, if someone breaks the sand bar or sand wall in front of the takeoff bar, that jump will be cancelled.
3. During approach run, no sign can be placed on the run way.
4. Jumping is not allowed with weight either in hands or legs.
5. While jumping, if the leg other than the required one touches the ground, then that jump will be cancelled.

2. Pole Vault: The jump that is performed exerting pressure or mass of the body on the pole is called the Pole Vault jump.

Roles for competition

- a. Inform the competitors about the height before starting the competition and how much height will be increased after the end of every round.
- b. After the end of every round, the crossbar would rise at least 5cm.

- c. For the convenience of jumping, the competitors can shift the posts up to 0.4 m from the edge of the inner portion of the box towards runway and 0.8 m towards the pit.
- d. When the competition starts, the jumping ground cannot be used for practice.
- e. The jump of a competitor will be considered unsuccessful if-
 - 1. Both legs float in the air.
 - 2. Crossbar falls or clutters after jump.
 - 3. The front ground of the crossbar is touched.
 - 4. Someone without jumping breaks or clutters the crossbar.
 - 5. Someone takes the lower hand upon the upper hand during jump while holding the pole or changes two hands and tries to mount by climbing.
- f. A competitor will have three chances for one height.
- g. Any substance can be used in hand for the efficient holding of the pole.
- h. While jumping, if the pole breaks, he or she will have the chance to jump again.
- i. If Tie occurs, the rule for Tie Breaking for Height will be applied.
- j. The length of runway would be 40 m and width 1.22 m.
- k. The measurement of Landing will be 5 m long and 5 m wide.
- l. Every competitor will use his or her own pole.

Technique: Pole can be handled in three way- 1. To carry the pole holding high, 2. To carry the the pole holding it in the medium height, 3. To carry the pole holding it low. It depends on the height and practice of the individual competitor how and in which manner he or she will hold the pole. Whatever be the manner of holding the pole, one has to jump entering the edge of the pole in the box.

Six Phases of Jumping

- 1. To rush towards the runway.
- 2. To place the pole properly in the box.
- 3. To take takeoff properly.
- 4. To mount high putting weight on the pole.
- 5. To swing the body on the crossbar.
- 6. To land without pole and swing the body.

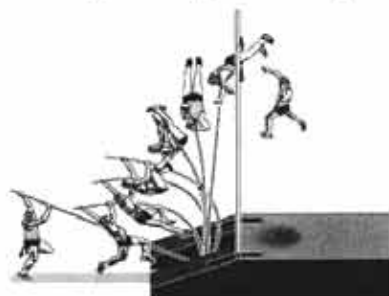

Pole Vault

Activity-1 : Show how Pole is held/gripped and carried.

Activity-2: Describe the various phases of jumping.

Activity-3: Ask the students to demonstrate the techniques of Triple jump.

Lesson-5: Throw Division/Department

During the Inter School and Madrasah Sports Competition, in this division or department, competitions on Sphere, Spear and Disc throw are usually held. The rules and techniques of these three events are described below:

1. Sphere Throw: The sphere will be made up of iron, brass or of similar substance. Its shape will be circular and smooth. The weight of the sphere for the male will be 7.260 kg and for the female 4.000 kg. The diameter of the shot put circle will be 2.135 m and the stroke of the sector will be 34.92° . This need to be placed in front of the circle of the stop board made of curved wood. The stop board will be of white color and would be firmly fixed with the ground so that it does detract at the blow of legs.

The Technique of Sphere Throw: The sphere would not be placed in the palm of the hand rather would be fixed with fingers fully clung to the base of fingers. The thumb and pinkie finger would be a little bit scattered two sides so that it does not fall. Then the sphere needs to be placed between neck and shoulder and the elbow of the hand will be a little bit elevated. The way or direction the sphere will be thrown: one has to stand with face opposite to that direction. The right leg will be forwarded and the foot of the left leg needs to be placed behind along with the ankle of the right leg. After that, the body needs to be squeezed backward while it would also move sideways.



Holding/Gripping the Sphere

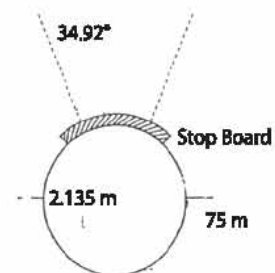

Shot put circle and sector

Rules

1. The sphere needs to be thrown in the sector.
2. If the number of competitors is 8, each of the competitors will have chances of 6 throws.
3. If the number is more than 8, selection should be made by three chances of throw. The selected competitors would have additional three chances of throw each.
4. After throw, the surface of circle cannot be touched.
5. One cannot get out of the circle until the sphere falls on the ground.
6. The sphere needs to be thrown within 60 seconds from the time the name of the competitor is pronounced.

2. Spear/Javelin Throw: The English term of spear is Javelin. The length of Javelin is 2.60-2.70 m for the male and 2.20-2.30 m for the female, while weight for the male is 800 gm and female 600 gm respectively. The length of the runway would be at least 33.5 m. An arc needs to be drawn with 8 m length and 4 m width. The arc would be made of wooden materials and placed parallel to the ground.

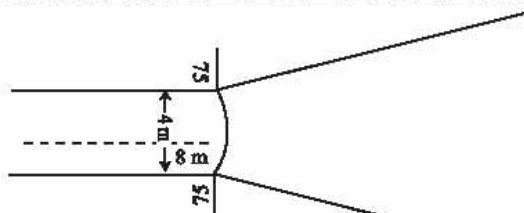

Sector and vanway of Javelin



The techniques of Sphere Throw

Technique of Javelin Throw: Firstly, one should know how to hold the Javelin. If the catch or hold or grip is good then the throw would also be good. The holding of Javelin is of three types-

- a. **Fore Finger Grip:** In this case, the Javelin is gripped with the fore fingers.
- b. **Middle Finger Grip:** In this case, it is gripped with the middle fingers.
- c. **In between fore and middle fingers:** In this case, it is to be gripped with the fore and middle fingers right in the middle.

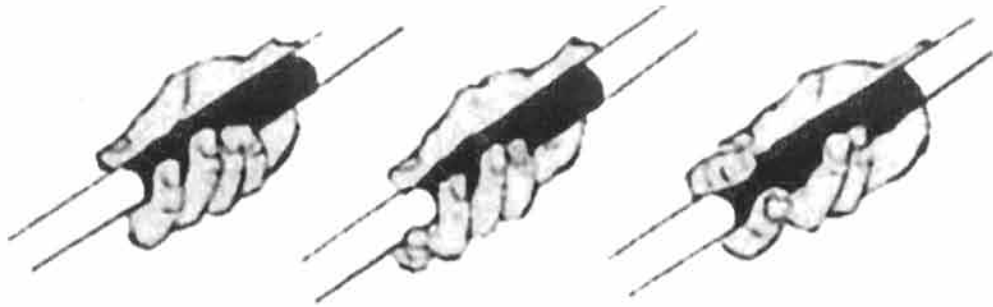

Javelin Gripping

Javelin throw has to be performed in four phases. These are- 1. Come running, 2. Rhythm of five steps, 3. Throw, 4. Retreat.

1. **Come running:** For Javelin throw, one needs to come running through the runway.
2. **Five Step Rhythms:** Before throw, one needs to take five steps with rhythm and then throw.
3. **Throw:** After five steps, one has to maintain equilibrium after the Javelin throw.
4. **Recovery/Retreat:** After equilibrium, one has to retreat/recover.

The Rules of Javelin Throw:

1. The Javelin must fall in the sector and the tip should first touch the ground.
2. It cannot be thrown touching the Javelin marker or the front marker.
3. After throw, one cannot cross the extended line.
4. One has to throw the Javelin within 90 seconds from his or her name being pronounced.
5. It cannot be clung with finger with tape or lace.
6. One cannot use gloves during Javelin throw.
7. One cannot use powder or similar substance to have tight grip.

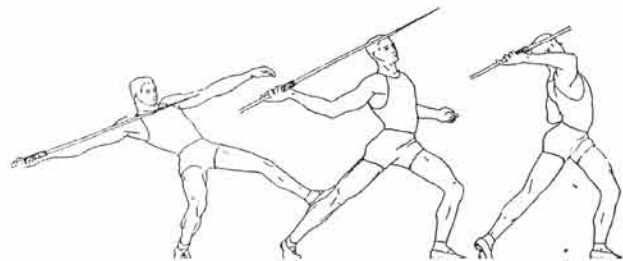

Javelin Throw

3. Disc Throw: Disc throw is a popular field event. The disc is actually circular in appearance. The weight of this disc for the male is 2 kg while for female 1 kg. The diameter of the circle for disc throw is 2.5 m. The circle should be circumscribed by iron ring and the circle will be rough and concrete-made.

The Technique of Disc Throw

Gripping of Disc

- First, the disc needs to be kept in the opposite hand.
- The smooth part of the disc will be upward facing.
- The disc has to be gripped tightly with the upper curve of the middle three fingers of that hand which would be eventually used for the throw of the Javelin.
- Support needs to be gained with the help of the thumb and the pinkie. Fingers should be spread.

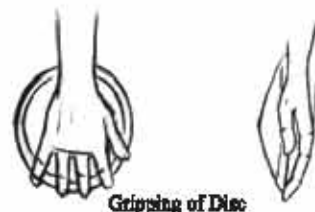

The Phases of Disc Throw: It has three steps such as 1. Swing, 2. Turn, 3. Throw.

1. **Swing :** The thrower would advantageously swing, gripping the disc tightly and standing in the circle.

2. **Turn:** Just before the throwing moment, the performer would have to swirl 1.5 times and then throw.

3. **Throw:** Soon after the turn, the performer has to take or gain strength on leg and throw. During throw, the performer has to maintain the equilibrium of the body on one leg.

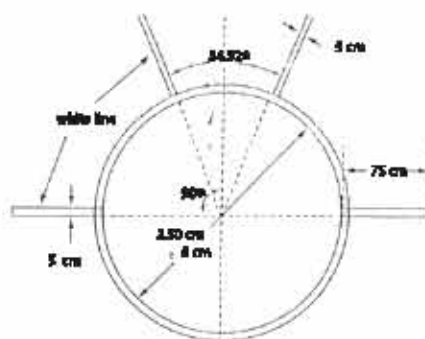

The circle & sector of disc

Rules

- Throw to be performed within 60 seconds from the announcement of the name.
- Disc to be thrown from within the circle.

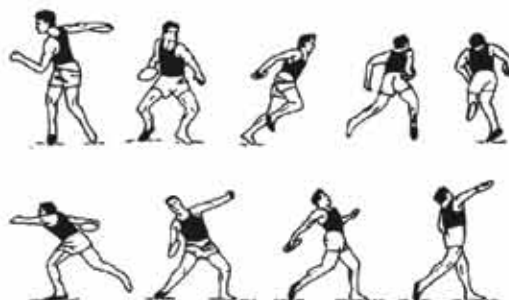

The Technique of Disc Throw

3. After throw, the performer has to get out of the circle from the hinder part.
4. The disc must fall in the sector.
5. While the disc is floating in the air, the performer cannot come out.
6. The iron ring round the circle should not be touched.
7. While throwing, the ground outside the circle should not be touched.

Activity-1: Ask the performers to show how to take grip of the disc and how to throw.

Activity-2: Demonstrate one different techniques of disc throw, sphere throw and Javeline throw.

Activity-3: Ask the performers/students to present the rules of those three types of throw.

Lesson-6: Swimming

Swimming is a very old game. In the ancient time, men have learnt swimming for survival. There was no necessity of any specific rules and regulations, tools and techniques. Later on, swimming competition event has emerged as a genuine medium of amusement and building sound physique. The pattern of swimming that we find common now-a-days was actually initiated by the English people. They first started swimming through breast stroke and side stroke. In 1873, the first competition on swimming was held in England. At a later stage, it spread throughout the world. After the independence of Bangladesh, the Bangladesh Amateur Swimming Federation was constituted in 1973. Since then, this federation has been carrying out various events of swimming in Bangladesh.

The Techniques of Swimming: Competitive swimming is of four types such as 1. Free Style, 2. Back Stroke, 3. Breast Stroke and 4. Butterfly.

A. Free Style Swimming: In this method, a competitor can swim in any style. But how the swimmer will go faster can be determined through repeated practice. For this purpose, the position of the body, the functions of legs and hands and the inhalation and exhalation are crucially important.

1. Position of the Body: The body is to be prostrated and kept parallel with water. The head will be little bit above water but the position of head sometimes needs to be accommodated through keeping head high or bending the shoulder.

2. Functions of Leg: The leg function starts from the hip and for moving forward while the left and right legs are moved upward and downward one after another. The leg is slightly folded at the point of knee but the foot of the leg is kept straight. The ankle of the left leg does not go above water. When water is pressed with the feet, the feet of the leg may go down up to 12-18 inches. In water, when the two hands would complete one full circle of movement, the legs would have 6 times upward and downward activities or circulations. The function of leg can be divided into two parts such as a. kicking upward, b. kicking downward.

3. Functions of Hands: Two hands need to be thrown towards the head in water. One hand while moving past water, will slide one side of the body up to the hip keeping the elbow a little bit folded. As soon as the hand propels upward, hand would reach in front of the head. As soon as the hand falls on water, the body needs to be pushed forward moving past the water. The fine-tuning and coordination of hands and legs increase the speed of the swimmer.

4. Inhalation and Exhalation/Breathing: While swimming, one needs to perpetually move the head and breathe keeping the mouth slightly above water. The hand that will be over water, the head needs to be turned to the direction of the hand that will be over water and the swimmer will have to breathe with mouth. But exhalation should occur when the mouth turns into the water.

B. Back Stroke: This technique is called back stroke as one has to keep the back on the water surface keeping face upward and swimming backward.

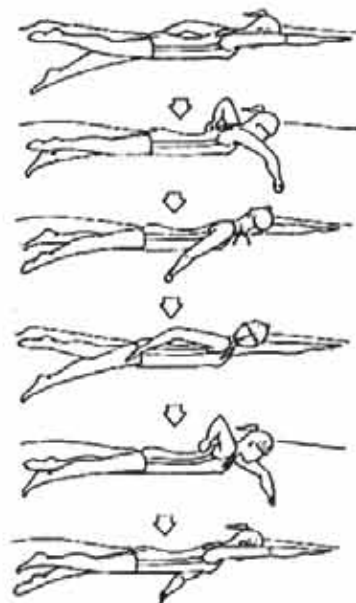

Freestyle Swimming.

1. Position of the Body: The body is kept with face upward and generally the head is positioned inside the water. As a result, the body floats on the water while the surface being parallel to water. The nose will not plunge into water but will be positioned above the water and eye sight will be towards the ankle of the legs.

2. Function of Legs: Like freestyle swimming, the function of legs is also important in this mode of swimming. In case of freestyle swimming, one has to prostrate the body and two legs, one after another, propel the body through water. Similarly, in this case, one has to fall on the back and move the two legs upward and downward. The feet of the legs will remain straight.

3. Function of Hands: In this case, one hand will go behind just beside the ear and will move past the water with palm and fingers of the hand and would ultimately reach beside the body while the other hand will go behind the same manner. One after another, one hand will go behind and come beside the body and with this process, the function of the legs will be simultaneously coordinated.

4. Breathing: Since swimmer falls on the back upon water in this mode of swimming where the face keeps at upward direction, the breathing will take place normally.

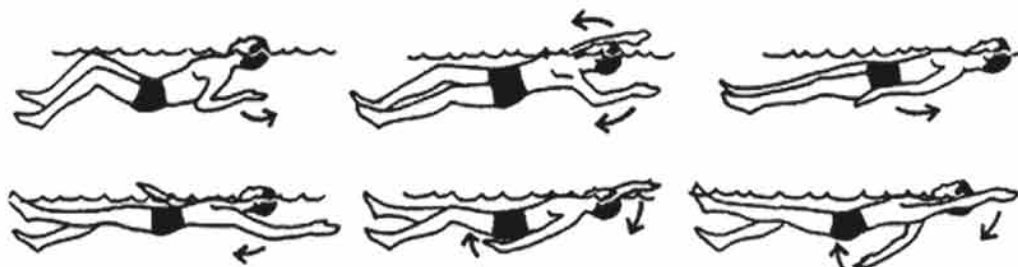

Swimming by falling on the back/ Supine Swimming

C. Breast Stroke: This is called Breast stroke as one has to swim exerting pressure on water through the breast.

1. Body Position: The body would be parallel with the surface of the water. The hinder part of the body will be partially plunged into water. The head will be over the water. After the functions of hands and legs, when the body will move forward, the nose and mouth will plunge a little bit into water.

2. Function of Legs: Two legs are to be kept together. Two hands will be thrown in front of the head and water will be moved past by the hands longitudinally beside the two sides of the body. At this time, the two knees will be folded and plunged into water and two ankles together will come closer to the hip and give heavy thrust on water.

3. Function of Hands: Two hands are to be extended forward together. Two hands will move past water together and while coming near the two sides of the body, the elbow will slightly bend. After the water being moved past, the two hands together would come in front of the face. At this time, the nose, mouth and forehead will be slightly plunged into water.

4. Breathing: After extending the hands in front of the face, when the hands will move past the water on both sides of the body, the mouth will rise from water for inhalation but exhalation should take place in the water.

D. Butterfly: Out of the four types of swimming, butterfly is the most difficult one. In this mode of swimming, the swimmer has to work very hard. He/she has to practice a lot as well to master the art of butterfly swimming technique.

1. Body Position: Like all other methods, the body will be in parallel position as much as possible. Since the body is moved forward and the swimmer has to breathe raising the head, so the hinder part of the body remains inside the water.

2. Function of Legs: Two hands will be close together. The more smooth the part from hip to leg is positioned, the more heavily water can be stirred with the paired legs. The legs are to be folded slightly and thrust in water downward and backward. The way Dolphins exert pressure on water through their tail, the paired legs will produce kicks in the sameway. These kicks are called Dolphin Kick.

3. Function of Hands: Two hands are projected together in front of the head. Then the two hands together exert pressure and move the body sharply forward. This process would be finely coordinated with Dolphin Kick of legs. When two hands are raised from within the water together, the swimmer appears to have the look of a butterfly. So, this mode of swimming is called Butterfly Stroke.

4. Breathing: When hands perform once, the legs' Dolphin Kick takes place two times. While maneuvering hands and the second time of the kicking of legs, the swimmer has to breathe through mouth. Then the head remains above water.

Turning: Turning is a very important part of swimming. If turning takes longer time, it will take more time. While turning, the speed of swimming cannot be reduced. A swimmer accordingly and chronologically performs the following functions:

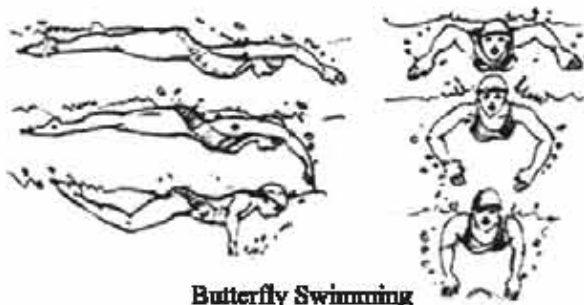

Butterfly Swimming

1. The swimmer has to prepare for going to the wall.
2. The body needs to be turned according to the techniques of turning.
3. The knees are to be folded and the two legs are to be placed near the wall.
4. If the feet of legs are properly set, the body can be well turned.
5. The swimmer has to come forward by giving thrust with legs.
6. While gliding, the body needs to be kept straight and move forward.
7. The functions of hands and legs need to start simultaneously.

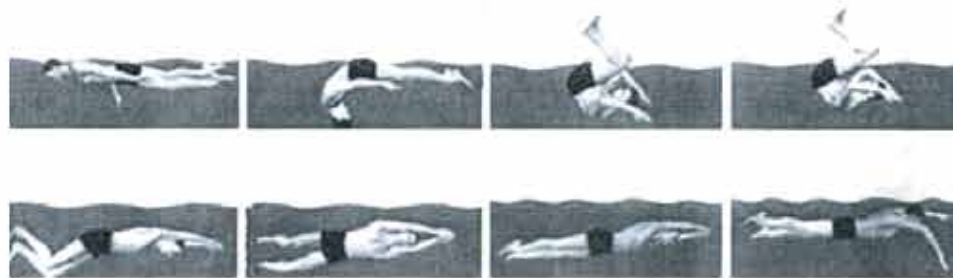

The Turning of Swimming.

The Guiding Principles of Swimming

1. An ideal swimming pool needs to be 50 m long and 21 m wide.
2. An ideal swimming pool has 8 lanes; each lane is 2.5 m wide, and 1.8 m deep.
3. The starting point will be rough and will be 0.5-0.75 m above water.
4. The starter, at the time of start would utter "Take Your Mark", "Set" and "Fire".

5. Except supine swimming, all other swimming needs to be started with diving.
6. In the hit, whoever becomes 1st and 2nd will be given lane 4 and 5.
7. In case of Supine swimming and Freestyle swimming, swimming can be completed by touching the finishing wall with one hand but Breast and Butterfly swimming requires both hands.
8. If a swimmer starts with one style and jumps to another, he or she will be disqualified.
9. In case of Back Stroke Swimming, the swimmer needs to hold the handle that remains fitted with the wall and push with legs and start the swimming from supine mode.
10. A swimmer cannot change lane or obstruct another swimmer in swimming.

Medley Relay: When four swimmers swim for the same distance with four different styles is called Medley Relay. These are- Supine swimming, Breast Stroke, Butterfly and Freestyle.

Personal Medley: When a swimmer swims alone with these four styles, it is called to be Personal Medley. The sequence of this relay is- Butterfly, Supine swimming, Breast Stroke and Freestyle swimming.

Activity-1: Ask the students/trainees to show freestyle swimming by bringing a long bench in the field.

Activity-2: Ask everyone to practice the movement of hands by bending the body forward keeping them arranged in two rows.

Lesson-7: The Qualifications of the Athletes and the Swimmers

Qualifications vary according to the nature and number of events. The same kind of qualification is not required for all events. For a specific event, an athlete or swimmer requires specific qualifications and other qualifications which again vary with the shift of events. As for example, the qualifications of a marathoner are not the same with that of the thrower. Since athletics and swimming competitions are event-related the success of the incumbents or contestants depends to a great extent on the personal or individual tools and techniques. Following is the description of the competitors of the athletics and swimming competition:

1. **Physical Fitness:** Every game and event requires physical fitness. Some game requires more strength; some require breathing while other requires speed and velocity, alacrity and readiness. But it should be kept in mind that the physical fitness varies with the number and nature of events.
 - a. **Sprinter:** Out of all the components of physical fitness, a sprinter requires the strength of the body the most. Especially the robust structure of the leg muscle is vital. With this, it also requires speed and velocity.
 - b. **Marathoner:** Out of all the components of physical fitness, a marathoner requires the breathing capacity most. Those who have good breaths fare well in these events.
 - c. **Short Distance Swimmer:** Out of all the traits of physical fitness, these performers require the strength of hands and elasticity of body though other fitness is also important.
 - d. **Long Distance Swimmer:** The first qualification required for this event is breathing. Floating on water is another important qualification as well. Apart from that, these performers also need to excel in the movement of hands and shoulders.
2. **The Efficiency of Mastering over various Tools and Techniques:** Since these two competitions depend on individual performance, Reaction Time plays a vital role.
 - a) **Reaction Time:** Running and Swimming need to be started soon after firing; hence one requires a very good reaction time. For Sprint and short swimming, starting is very important.
 - b) **Qualification to touch Ending Point:** Qualification for touching the ending point is also very vital. Be it athletics or swimming, in both the cases, one need to acquire efficiency in touching the ending point.
 - c) Those who are throwers, need to acquire skill in turning, throwing and Follow Throw.
 - d) **Knowing the Rules and Norms of the concerned Events:** One needs to master the rules, regulations, norms and etiquette of the concerned events to fare well in such competitions.
 - e) **Self-confidence:** The competitors must acquire self-confidence. If one does not have firm determination and high morale, one cannot fare well in such competitions.

- f) Discipline and Obedience:** Every competitor has to practice with discipline and take rest properly. Each competitor needs to abide by the instructions and do's and don't's of the teachers and demonstrators.

Activity-1: Ask the students to be divided into two groups where one group would discuss the requisite qualifications and efficiency for event-wise swimming competition while the other group would discuss in the same way the athletics.

Activity-2: Ask the students/trainees to describe the rules and norms of starting and ending points for swimming.

Exercise

Multiple choice questions

- Which one is the first stage of high jump?
 - take off
 - come running
 - cross the cross bar
 - landing
- In which swimming do the chest and mouth of the swimmer remain upward ?
 - breast
 - free
 - back
 - butterfly
- Which colour is given on the take off board?
 - white
 - red
 - yellow
 - green
- Which game is related to the word 'take off' ?
 - athletics
 - football
 - hockey
 - cricket
- Which swimming is started without dive?
 - breast stroke
 - butterfly stroke
 - free stroke
 - back stroke
- In high jump when does a competitor get a chance ?
 - jump in 60 seconds
 - if take off is taken with two legs
 - if running starts from 16 meter away
 - jump in 90 seconds

7. In personal medley, the serial of relay stroke is
- a. breast, back, butterfly, free
 - b. butterfly, back, breast, free
 - c. back, breast, butterfly, free
 - d. free, back, butterfly, breast

Read the stem and answer questions 8 & 9.

Samin is always good at playing. In the last annual sports competition he became the personal champion along with occupying the 1st position in 100 and 200 meter sprint. After his success, his brother advised him to practise swimming along with athletics and by regular swimming practice, he was awarded with the glory of becoming 1st in an event of swimming at national level. He becomes 1st in the swimming that requires hand work for one time.

8. In which swimming did Samin become 1st?
- a. free
 - b. relay
 - c. breast
 - d. butterfly
9. Which capability of athletic Samin works as a background of success of swimmer Samin?
- a. gaining more rapidity
 - b. gaining more strength
 - c. taking nutritious food
 - d. gripping the technique

Creative Question

1. Shabbir took part in the inter school swimming competition. By keeping his body floating on water in parallel line, he advanced forward paddling with the two hands after throwing them long in front of his head and by lifting his mouth over water, he tried to take breath. He could not stand first in the competition. In doing better in swimming the physical instructor advised him to fulfill two conditions by practicing and instructed him to increase capability.
- a. What is torso?
 - b. What is called the raising up by placing the weight on the ground?
 - c. In which event of swimming did Shabbir participate? Explain.
 - d. It is possible to be first by hard practice - analyse according to the stem.

Chapter Ten

The Accidents during Games

Temporary obstacles are created in our day-to-day life through various tangible and intangible accidents. These accidents may occur in various ways. Accidents like sudden pain in legs from any source, bruises or fractures in legs or elsewhere or wounds, sores may happen any time during exercise or games. Accidents occur suddenly or with uncertainty. At that moment, doctors are usually not available. But the patient needs first-hand care or first aid that very moment. That is why we need to be aware of First Aids. Through building knowledge on First Aid, we would be able to lead a hazard-free and healthy life.



The components of First Aid

At the end of this chapter, we will be able to–

- describe the importance and methods of First Aid sequentially;
- describe the elements/components of First Aid;
- describe the features and importance of First Aid;
- describe the causes and Remedy of the bruised and swollen skin;
- describe the first-aid essentials for wounds, fractures of bones, sores and traumatic conditions;
- explain the causes and remedies of the bruises or disjoints of ligaments and fracture and displacement of joints;
- describe the classification of bruises, cuts and sores;
- describe the remedies of wounds;
- explain the first Aid or emergency support in case of bleeding of nose and tension and cramping in the muscles of legs and elsewhere;

- describe immediate action in case of someone being drowned;
- describe the emergency Aid in case of someone being drowned;
- learn about various traumas like bruises in skin, swells, wounds, fractures, displacement of joints, disjoining of ligaments etc;
- be inspired about leading a healthy, hazard-free and happy life.

Lesson-1: The Importance, Method and Elements of First Aid

First Aid is a primary department or discipline of medical science. A person with appropriate knowledge of First Aid is capable of providing First Aid support to someone who falls a victim to an accident or suddenly falls ill. First Aid does not aim at providing full treatment. Because a volunteer of First Aid is not a physician. Until the doctor arrives or the patient is borne to a hospital, such volunteers try to save the life of the person affected, facilitates early recovery, prevent the patient's condition from turning worse. Thus the volunteer aims at saving someone's life with immediate and necessary medical assistance. If we describe the acronym of First Aid, the very definition and function of First Aid would be easier to comprehend.

F- Fast: The volunteer providing First Aid has to take quick action. Otherwise, the patient's condition might turn worse.

I-Investigation: Investigating the condition and surrounding of the patient, immediate decision needs to be taken.

R- Relief: First of all, the volunteer has to ensure to annihilate pain and make comfort for the patient.

S- Sympathy: The patient needs to be looked after with care and sympathy. Thus the patient would have courage and feel better.

T-Treatment: The volunteer would try his or her level best to provide treatment for the patient at the earliest and the fastest way.

A- Arrangement: After First Aid, arrangements to be made for immediate disposal of the patient to a doctor or nearby hospital.

I- Immediate: Immediate action is required for patient, which means that patient should be either borne to a doctor or nearby hospital.

D- Disposal: The patient needs to be disposed from the area of accident. If the condition is not serious, then he or she should be borne home or if emergency and fatal, then borne to hospital.

The Method of First Aid

1. Immediately but with care and attention, the first action should be taken first and the later part to be done accordingly.
2. The patient needs to be borne/taken to a safer place from the point of accident.
3. The patient needs to be investigated whether the patient has conscience or not.
4. If respiration is obstructed, artificial method needs to be adopted for respiration.
5. If bleeding continues, it must first be stopped.
6. If the patient is electrocuted, the first emergency treatment should be done without delay.
7. The pulse should be keenly observed.
8. If the patient is senseless, the cloths should be detached or severed from the body.
9. The patient and his or her companion should be given hope and mental support.
10. Bystanders need to be dispersed as much as possible.
11. Adequate lighting, ventilation and air passage should be ensured.
12. The volunteer should observe very cautiously the following symptoms:
 - a. The apple of eyes normal or abnormal.
 - b. The face is gloomy or natural.
 - c. The head has any severe blow or injury or is bleeding or not.
 - d. Shivering is either with fear or for cold and to decide whether the patient requires heat or not.
 - e. Arrangements to be made for immediate disposal of the patient to the nearest doctor or hospital.

The Components of First Aid

The following components or elements or items are essential in case of First Aid:

1. Sterilized cotton or gauze
2. Lint
3. splint
4. Pad
5. Scissors
6. A triangular and a roller bandage
7. Dettol
8. Pad, Flat Pad and Ring Pad
9. Iodine
10. Benzoin
11. Forceps
12. Safety Pins
13. Blades and needle for stitching
14. Spirit
15. Leucoplast
16. Eye pad
17. One tube Burnol
18. A tray for medicine
19. A syringe
20. A First Aid Box.

Activity-1: Ask the students to write on poster about the importance of First Aid.

Activity-2: Ask the students to write the do's and don't's of the volunteers of First Aid.

Activity-3: Spreading the different components of the First Aid materials, ask the students to identify them and arrange them chronologically.

Lesson-2: The Features/Qualities of the Volunteer of First Aid

- 1. Observation Power and Knowledge:** Such a volunteer can easily perceive the cause and signs of injury.
- 2. Intuition:** A volunteer does not do any unnecessary activity but tries to intuit the symptoms of injury and takes drastic action which makes him or her credible and creditable to all.
- 3. Experience:** A volunteer with experience can serve the purpose of the patient with whatever materials he or she finds around him or her without losing time. He or she also ensures that whatever injury the patient has so far sustained might not aggravate further.
- 4. Efficiency:** The volunteer has to notice that patient does not suffer unnecessarily. In the light of experience, he or she performs his or her duty very easily and dexterously.
- 5. Right Advice:** A volunteer gives advice to the attendant and present close relatives of the patient about their duties and responsibilities.
- 6. Right Decision:** The primary attendant would prioritize his or her service towards the patient and perform them chronologically.

7. Confidence: If difficulty arises, the volunteer does not lose hope or gets lost; rather he or she performs his or her first medical support with due sincerity and confidence.

8. Sympathy: An ideal volunteer never turns harsh towards the patient. He needs to care the patient, share his or her pains and complains and encourage him or her and his or her attendant and relatives.

Activity-1: Discuss in groups about the qualities of a volunteer primary attendant.

Activity-2: According to you, what qualities of such volunteer you think are very crucial.

Lesson-3: Bruises of Skins, Tension in Muscle and Tendons and Swells

During our day-to-day activities and games, we may fall victim to any accident or succumb to any injury. If one has sufficient knowledge of accidents and traumas, one can skip such hazards sometimes and if unfortunately it occurs, one can undergo primary treatment and take necessary measure immediately before disposing the patient to the concerned physician or the nearest hospital. It is very likely that we may succumb to grievous injury from simple injury during games and sports.

To avoid or skip such injuries, the following steps can be adopted:

1. Before exercise or games, the body should be properly warmed up.
2. One should avoid excessive exercise or games.
3. One should select his or her peer according to his or her height and weight.
4. One should not play on rough surface, slippery ground or wet and zigzag ground.
5. One should not play near trees or pole of electricity.

1. Bruises of Skin: Skin might be bruised by the blow of playing boots, or by a hammer, stone or any blunt substance. In that case, the skin becomes smashed or trampled, blood-stained and black-spotted.

First Aid/ Primary Remedy

1. Cold water or ice needs to be applied to the affected area.
2. A neat and clean piece of cloth or towel soaked in cold water needs to be tightly fixed round the affected area. When it gets dry, more cold water should be poured on it.
3. If the affected area bleeds, then measures should be taken to stop the bleeding.
4. Sterilized cotton should be used to wash the stained blood and ointment should be applied.
5. If necessary, the patient should be referred to the doctor.

2. Tension or Cramping of Muscle or Tendon: While playing or lifting some heavy substance, the muscle or tendon might sustain injury resulting in some sort of tension or cramping. In this case, the fine fiber of muscles are torn causing painful sensation and severe difficulty in walking. Sometimes, the injured place swells or turns blackish. This condition is called muscle pool or tension of muscle. If so happens, the affected area needs to be at rest and then ice should be applied to that place. After 24 hours, the compression with hot water and boric powder needs to be applied. Athletes and Swimmers often succumb to such injuries of muscle and tendon.

3. Swells: Sometimes, some parts of the body swell by the injuries of playing boots or by the blow during boxing, or injuries by falling and thus create swelling in the affected area. The first course of action is to apply dry ice or ice or at least cold water. After applying ice for a while, the swell will reduce in size. If pain still persists, the injured should consult the doctor.

Activity-1: Ask the students to show how to remedy if skin bruises.

Activity-2: Describe the remedial action for tension or cramping in the muscle.

Lesson-4: Disjoining, Wounds, Bruises, Fractures and Tearing of the Ligament

1. Disjoining: Where a bone joins another bone it is called the bone-joint. It is the concurrence of two or more than two bones. If a bone is displaced from the point of joining, it is called disjoining of bone. Sometimes the shoulder, elbow,

wrists, thumb, lower jaw-bone, knee or the ankles of legs may be displaced from the adjoining point. Sometimes, disjoining and fracture happen simultaneously.

Symptoms: 1. The joints would swell, 2. Feeling of pain in the joint, 3. Disability to move the joints, 4. Assume abnormal shape by the misplacement of bone of the joint.

1. First Aid for Disjoining

1. The affected area needs to be at comfort as much as possible.
2. The affected area should not be moved.
3. The misplaced bones need to be joined or attempts should be taken to join them.
4. Joint should be treated with cold water or ice.
5. If necessary, the bandage for bone fracture should be used.
6. If the patient is electrocuted, proper steps should be taken.
7. If doubt is prominent that bone has sustained fracture, the bandage for bone fracture should be used.
8. The patient should be immediately transferred to the concerned doctor or the nearest hospital.

2. Bruise or Fracture

The robust ligament keeps the bones and soft tissues at the joining point adhered and clung tightly. If this ligament is tensed or torn for some reason, it causes severe pain at the joining point and the affected area becomes swollen. This is called bruises of bones. When bruise happens during games or exercises, the affected area should be kept at a comfortable place. After that, thick layer of cotton should be laid on the upper and lower side of the affected area and firmly bandaged.

Fracture: If any bone of the body is broken, this is called Fracture. Fracture may be of various types such as 1. Ordinary Fracture, 2. Compound Fracture, 3. Complicated Fracture.

1. **Ordinary Fracture:** This Fracture happens in the inner part of the body.

Firstly, attempts should be made to join the bones keeping the tip of the bones straight. Then the affected area should be made immobile by fastening with a splint.

2. Compound Fracture: It is also called open fracture. Because in such cases, the broken bone comes out penetrating the skin. In this case, the broken bone should be bandaged straight as much as possible and that part should be made immobile.

3. Complicated Fracture: In this case, the sharp corner or the tip of the broken bone generally affects some important part of the body such as kidney, liver, lungs or blood vessel. Apart from these, there are some other categories of Fracture such as-

1. Comminuted: In this case, the bone breaks into several pieces.

2. Impacted: In this case, the edge of broken bone collides and gets inside with each other.

3. Greenstick: Sometimes especially in case of children, the bone does not fracture rather has some fissure.

What needs to be done for Fracture?

1. The treatment of the patient should be started immediately. It should be done as sudden transfer of patient is not possible.
2. The affected area should be made immobile.
3. Splint should be used to make it immobile.
4. Efforts should be made to transfer the patient to hospital as soon as possible.

The tearing of Ligament: The ligament is related with joint. It is surrounded with tendon and membrane on the joint. A flat bracket is called ligament. Ligament helps movement of two bones. Above the ligament is the bracket of tissues which makes the joint more robust. If the leg falls on unparallel ground or place, a sudden jerk severs the ligament. Sometimes, while running, if the joint is injured, the ligament is torn. The affected area becomes swollen and severe pain is felt. It becomes difficult to move that limb. In this case, ice should be immediately applied and patient should be put on rest. Later, he or she should be borne to hospital or a doctor.

Activity-1: Why does disjoints happen? What are First Aid prescriptions for this?

Activity-2: What are various types of Fracture? Describe the remedial measures for fracture.

Lesson-5: Various types of Wounds and Remedies

If some fiber of the body is lacerated or breaks into two or more parts or if that fiber is perforated, it is called wound. If the skin severs or bleeds, or is incised it is also called wound. Wounds are generally of five kinds-

1. Confused Wound.
2. Lacerated Wound.
3. Incised Wound.
4. Punctured Wound.
5. Mixed Wound.

a. Confused Wound: Sometimes, the fine fibers and cells which are ingrained in the human body when affected by a heavy substance or hard blow or wound, it sometimes causes no harm to the skin but the internal capillary are affected causing internal bleeding. Since that blood has no scope to drain, it sediments inside and creates wound which is generally called confused wound. In this case, no visible bleeding occurs.

b. Lacerated Wound: The wound that occurs due to attack of wild animals, or being smashed under a machine or firing is called lacerated wound. This wound is usually unequal and scattered.

c. Incised Wound: The wound that takes place due to bruises by some sharp weapon such as blade, knife, broken glass, or fish-knife, is called incised Wound. In this case, the skin and blood vessel are cut very sharply and smoothly causing incessant bleeding which becomes difficult to stop.

d. Punctured Wound: This wound is usually deep. The top of the wound is rather small or narrow. This sort of wound is caused by needle, nails, wires etc. In this case, bleeding might not be severe.

e. Mixed Wound: When a wound happens in combination with more than one wound, it is called Mixed Wound. The wound from a bullet is such that the diameter of the wound at the front is narrow but inside wound is very large and bigger in diameter which cannot be sensed from outside. Again, the point from which the bullet comes out has a big and uneven wound. This wound is in one side a punctured wound and on the other side is a lacerated wound. Both of such wound create is such mixed wound.

First Aid for Wounds

1. The patient needs to be laid on ground at ease and kept motionless.
2. The wounded limb should be kept above heart level so that circulation of blood from the wounded part decreases and finally stops bleeding.
3. Soon after such wounds, ice should be applied.
4. The patient should be made as much immovable as possible.
5. The wounded limb or part should be washed by some antiseptic liquid.
6. To stop bleeding, direct or indirect pressure should be exerted.
7. If something hard gets into the wound, it should be taken out.
8. If there are blood sediments on the wound, that blood should not be washed or erased.
9. If someone is electrocuted, his or her treatment should be done immediately.
10. Sterilized pad should be used on the wound.
11. Wounded part should be made still and motionless fastening with bandage.
12. The patient cannot be allowed to take any stimulating thing or drink.
13. The patient needs to be borne to a doctor or nearby hospital.

To provide treatment for wound to a patient, one needs to have some knowledge on First Aid. These are-

- a) How the bruise has happened and to which category it does fall, whether it is a confused, or lacerated, punctured or incised wound are the deciding factors the volunteer has to be sure about it.
- b) The do's need to be fixed first. If it bleeds, then stopping bleeding is the first course of action. The volunteer needs to notice that septic does not happen. The patient might be advised to take Toxoid Injection.

- c) If such wounds happen, actions need to be taken to wash them and if it bleeds, that must be stopped first. Then the volunteer needs to take care so that infection does not happen. If someone is electrocuted, then he or she must be provided with First Aid support.
- d) If one is electrocuted, the breathing should be fixed first.
- e) Depending on the condition of the patient, he or she needs to be borne to hospital.

Activity-1: What do you mean by wounds? How many kinds of wounds there are and what are they? Write them all on a poster and hang that on the wall.

Activity-2: Be divided into four groups and discuss the First Aid support and present it, coming in front of the board.

Lesson-6: Bleeding from Nose, Drowning methods to rescue and provide Artificial Breathing

1. Bleeding from Nose: If someone is slightly hurt, it may so happen that the nose starts bleeding. This frequently happens in boxing.

- a) The patient should be either seated on the chair or laid upon the back on even floor and the face should be leaned little bit backward.
- b) The patient should be asked to breathe with mouth.
- c) The nose needs to be held with slight pressure.
- d) The sedimented blood need not be drained out; otherwise, it would cause more bleeding.
- e) If ice or cold water is applied, it helps stop bleeding fast and easily.

2. Drowning: We have numerous ponds, rivers and drains around us. So, everyone should know how to swim. If someone does not know swimming, one should never bathe in such places. Accident might happen by legs being slipped in the pond or river. If one does not know how to swim, he or she should rather fetch water and bathe. If someone falls in such water, immediately, some floating substance should be thrown to that person or rescue

him or her by swimming. But care should be given that the drowning person might not endanger the life of the rescuer by clinging him or her tightly. If the affected person drinks too much water, then steps should be taken to let water drain out otherwise the water entering into the respiratory tunnel might stop breathing. A drowning patient should be given the following First Aid support:

If the patient is a baby then-

1. The ankle of the legs should be turned upward. Sometimes, the back should be patted. As a result the water drunk during the incident would drain out. If some water plant enters into the body, it would also come out.
2. Artificial breathing should be arranged.
3. The soaked dress should be taken off.
4. Until medical support is availed, artificial breathing should be continued.

If the patient is an aged or grown up person, then-

- a) The neck and mouth of the patient should be properly washed.
- b) The patient should be seated on a chair or stool folding his or her knees in such a way that the head hangs. If the back is patted, the water entered inside during drowning would be drained out.
- c) The wet dress should be taken off.
- d) Artificial breathing should be carried out until the patient is hospitalized.

Artificial Breathing: When a patient stops breathing or is about to stop breathing, the volunteer has to make arrangement for artificial breathing. Artificial breathing is administered manually or through machine. By pushing with hands artificial breathing should be started. It actually means and includes that the patient's lung can fluctuate 10-12 times per minute. As soon as the lung squeezes, the air comes out and it is called inhalation. When the lung enlarges, air enters and this is called exhalation. There are some specific methods for artificial breathing. The most popular and widely used methods are-

- a. Schafer Method.
- b. Silvesters Method.
- c. Holger Neilson Method.
- d. Mouth to Mouth Method.

A. Schafer Method: The patient has to be laid with face downward in supine position. His or her nose will face the ground. The two hands will be scattered on the two sides of head. The head should be slid one side so that the nose does not touch the ground. No time should be wasted to unzip or undress the patient. The First Aid volunteer should face towards the head of the patient and make

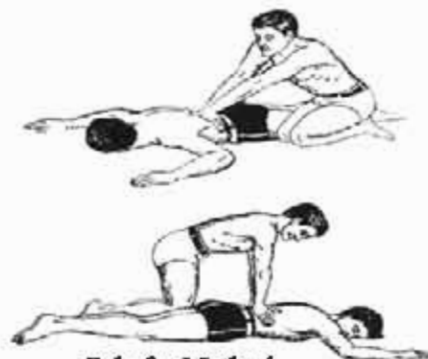

Schafer Method

his or her position parallel with the hip and then folding his or her knee, the volunteer would kneel down beside him or her. Then he or she would place both the hands on both sides of the hip in such a way that the thumbs would face forward and other fingers would remain scattered longitudinally on both sides of the hip. The hands and elbow need to be kept straight forward. Then without bending elbow, the volunteer would hang forward and press. This exertion of pressure and withdrawal of pressure functions needs to be done one after another within 5 seconds. Exertion of pressure for 2 seconds and withdrawal of pressure would take 3 seconds. This would continue until the breathing comes to normalcy.



Holger Neilson Method

B. Silvesters Method: The patient needs to be laid with face upward in supine position. A small pillow should be placed under the neck of the patient. His or her head should be placed on the pillow in such a way that the head remains in the front. The clothes need to be taken off from the body. Notice should be given that the patient does not stop breathing reversing the tongue. The patient needs to be laid flat and his or her elbow should be moved upward forcibly so that it creates pressure on both sides of the chest. In this way,

pressure has to be exerted and later withdrawn. Total time for this emergency support is 5 seconds. Placing one piece of paper, the volunteer needs to examine whether the patient has recovered breathing or not. This process should continue as long as the breathing comes to normalcy.

C. Holger Neilson Method: The patient needs to be laid upside down/prostrated.

- The volunteer needs to sit kneeling down and leaning against the head of the patient.
- The back of the patient needs to be patted. Then the two arms of the patient need to be moved up and down. It should be kept in mind that if there is a fracture at the shoulder joint or fracture adjoining to the shoulder, then this method is not operative.

The rule for exerting pressure-

- a) First and second steps are to create pressure on the back.
- b) The third step is to stop for a while.
- c) The fourth and fifth step are to create tension on the arms.
- d) Sixth steps are to stop for a while.

In this method, the patient should breathe 10-12 times a minute. Every time, the rate of passing the air is 1 liter.

D. Mouth to Mouth Method: A very easy and handy method is this Mouth to Mouth method. By this method, air can be blown into the lungs. This method requires less effort and energy as well. Even the youngsters can easily apply this method. But from the view point of morality, this method creates some obstacles. If a baby does not breathe, this method has been in application from time immemorial for artificial breathing. The main aim of this method is to save the life of the drowned person. The volunteer first has to wash the inside of the mouth, then has to hold the head of the patient very tightly and the other hand is to be placed on the lower jaw. The mouth of the patient is to be opened wide and after inhaling breath to the full, the volunteer fits in his or her mouth into the mouth and lips of the patient keeping it airtight and blows the oxygen into the lungs of the patient to his her full capacity. This way, the volunteer has to blow air into the lungs of the patient for 10-12 times.

Activity-1: Describe the means and techniques to stop bleeding from the nose and present the same in the class.

Activity-2: What do you mean by artificial breathing?

Activity-3: Out of the various methods of artificial breathing, show practically the one you think easier for you.

Exercise

Multiple choice questions

1. Which condition is called muscle pull?
 - a. if the skin is torn
 - b. if there is pull of muscle
 - c. when there is swelling of any part of the body
 - d. if ligament is torn
2. What happens due to detachment of joint?
 - a. the bone is displaced
 - b. ligament is torn
 - c. a wound is created
 - d. the bone is broken
3. How is the broken bone kept immobile?
 - a. lint
 - b. splint
 - c. bandage
 - d. pad

Read the stem and answer questions 4 & 5.

At the end of school due to the knock of an auto rickshaw Rony fell down while he was crossing the road. The people on the road took him to the hospital and the doctor, after examining found that the bone of his legs had been broken into various pieces. After necessary treatment the doctor sent him home.

4. What was the type of Rony's broken bone?
 - a. comminuted
 - b. impacted
 - c. green stick
 - d. complicated

5. In treating Rony's broken what the doctor said is that.

- (i) the injured place will be kept immobile
- (ii) the injured part will be kept immobile by using a splint
- (iii) more fomentation will be given.

Which one in the following is correct?

- a. i & ii
- b. i & iii
- c. ii & iii
- d. i, ii & iii

Read the stem and answer questions 6 & 7.

Going on a visit to Cox's Bazar, Shakil was drowned due to the knock of the wave during his bath in the sea. After saving him, a visitor laid him turning and sitting by the side of his head. He pressed his back and made his two hands up and down.

6. What is the name of the method applied to Shakil?

- a. Holger Neilson
- b. Sylvester
- c. Schafer
- d. Mouth to mouth

7. Why was Shakil's back pressed?

- a. for talking to the patient
- b. for soothing the patient
- c. for artificial breath
- d. for getting out water from the abdomen

Creative Questions

1. Going to a tour to Cox's Bazar with his friends, Ranjhu was drowned in the sea. After a while he was floated. Then the friends lifted him up and for making his breath normal, they took the breath mouth to mouth. For getting out water from his abdomen they cleared the mouth and the throat. At last he came round.

- a. What is impacted?
- b. What is meant by artificial breath?
- c. Explain the method of mouth to mouth in the case of making Ranjhu's breath normal.

- d. After Ranjhus mouth and throat were cleared, he came round. Do you agree with this statement? Give a reason in favour of your answer.
2. Marium gets hurt on her heels in a road accident. Her legs become swollen. As a result she feels a great pain. One of the rescuers observes her wound and applies cold water on the wounded area and forbids her to move.
- What is comminuted?
 - What is meant by detachment of joint? Explain.
 - What kind of hurt does Marium experience? Explain.
 - Do you think that the activity of the rescuers is sufficient for Marium's treatment? Give a reason in favour of your answer.

The End



প্রমীলা ক্রিকেট: এশিয়া কাপ জয়

২০১৮ সালের জুনে মালয়েশিয়াতে অনুষ্ঠিত উইমেন্স এশিয়া কাপে ভারতকে হারিয়ে বাংলাদেশ শিরোপা অর্জন করে। এই টুর্নামেন্টে ছয়টি দল অংশগ্রহণ করেছিল। ২০০৮ সাল থেকে এই টুর্নামেন্টে অংশগ্রহণ করলেও সালমা খাতুনের যোগ্য অধিনায়কত্বে সপ্তম এই টুর্নামেন্টে প্রথমবারের মতো বিজয়ীর ট্রফি হাতে নেওয়ার গৌরব অর্জন করে বাংলাদেশ।

2023

Academic Year

9-10 Physical Education

শিক্ষাই দেশকে দারিদ্র্যমুক্ত করতে পারে
– মাননীয় প্রধানমন্ত্রী শেখ হাসিনা

তথ্য, সেবা ও সামাজিক সমস্যা প্রতিকারের জন্য '৩৩৩' কলসেন্টারে ফোন করুন

নারী ও শিশু নির্যাতনের ঘটনা ঘটলে প্রতিকার ও প্রতিরোধের জন্য ন্যাশনাল হেল্পলাইন সেন্টারে
১০৯ নম্বর-এ (টোল ফ্রি, ২৪ ঘণ্টা সার্ভিস) ফোন করুন



Ministry of Education

For free distribution from academic year 2010 by the Government of the
People's Republic of Bangladesh